

Jet Measurements at the LHC

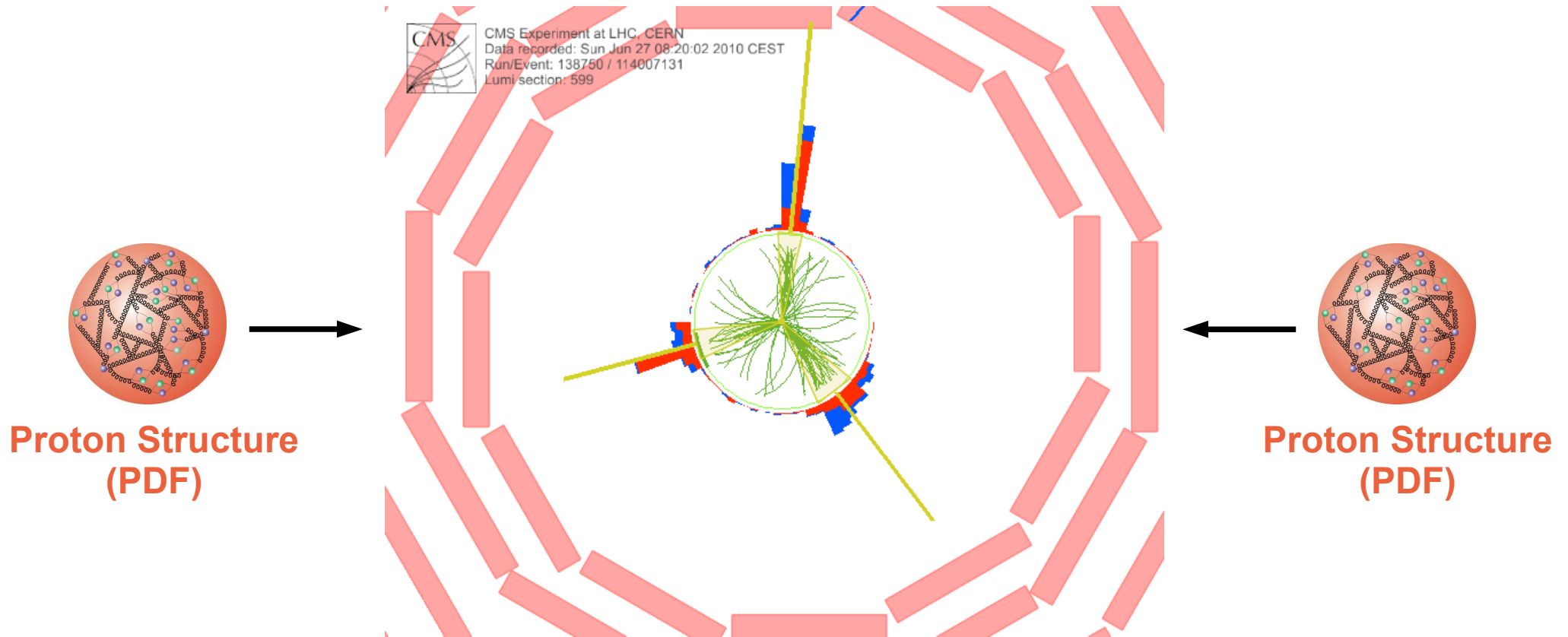

K. Rabbertz

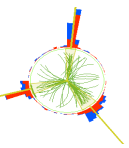



- **Lecture 1**
 - ➔ **A bit of history**
 - ➔ **Jet algorithms**
 - ➔ **Jet energy calibration**
 - ➔ **A first jet analysis:**
 - ➔ **Inclusive jet cross section**

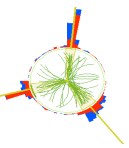

- R.K. Ellis, W.J. Stirling, B.R. Webber, “QCD and Collider Physics”, Cambridge University Press, 1996.
- G. Dissertori, I.G. Knowles, M. Schmelling, “Quantum Chromodynamics”, Oxford Science Publications, 2002.
- J. Collins, “Foundations of Perturbative QCD”, Cambridge University Press, 2011.
- R. Cahn, G. Goldhaber, “The Experimental Foundations of Particle Physics”, Cambridge University Press, 2nd Edition, 2009.
- I. Brock, T. Schörner-Sadenius Eds., “Physics at the Terascale”, Wiley-VCH, 2011
- Particle Data Group, “The Review of Particle Physics”, Chin. Phys. C38, 090001 (2014), <http://pdg.lbl.gov>.
- G. Salam, “Towards Jetography”, Eur. J. Phys. C67, 637 (2010).
-

Problem 1: The Particle Zoo

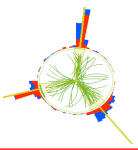

- **Kosmische Strahlung und die Entwicklung von Beschleunigern sorgen in den Jahren 1947 – 1970 für die Entdeckung vieler neuer “Elementarteilchen”!**

- ➔ **M. Gell-Mann, 1964:** Bringt erste Ordnung in den Zoo über den Eightfold Way: Anordnung der Mesonen (links) und Baryonen (rechts) in Schemata nach Ladung q und “Strangeness” s sortiert:



nobelprize.org

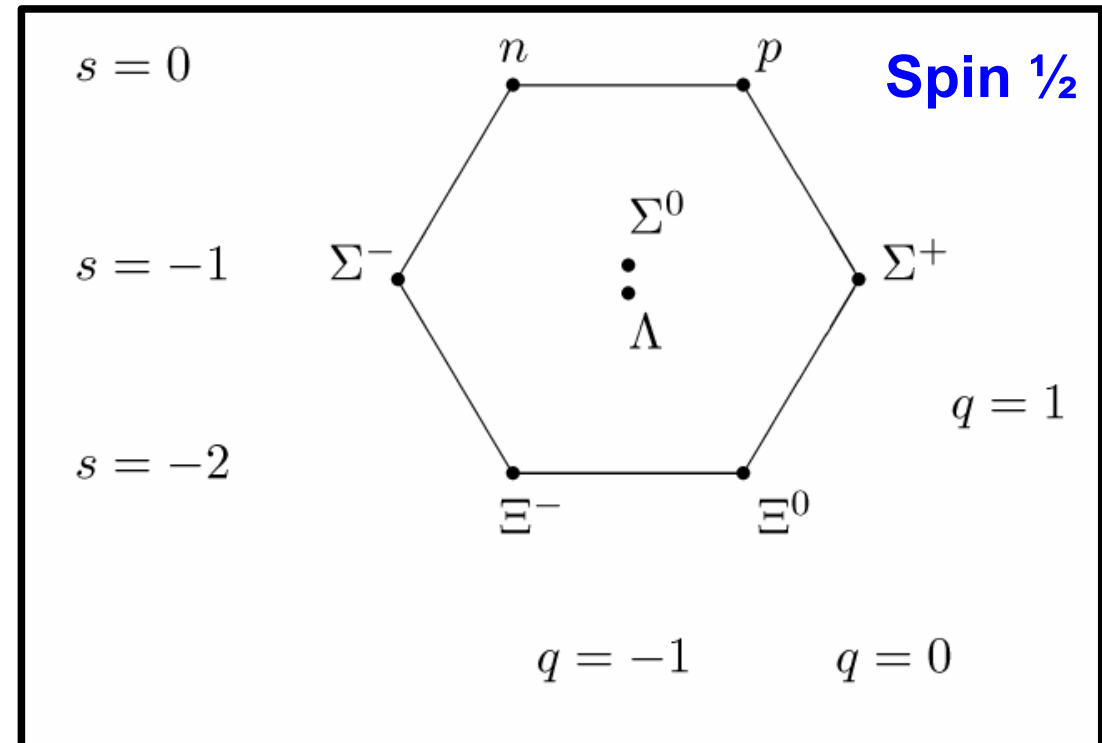
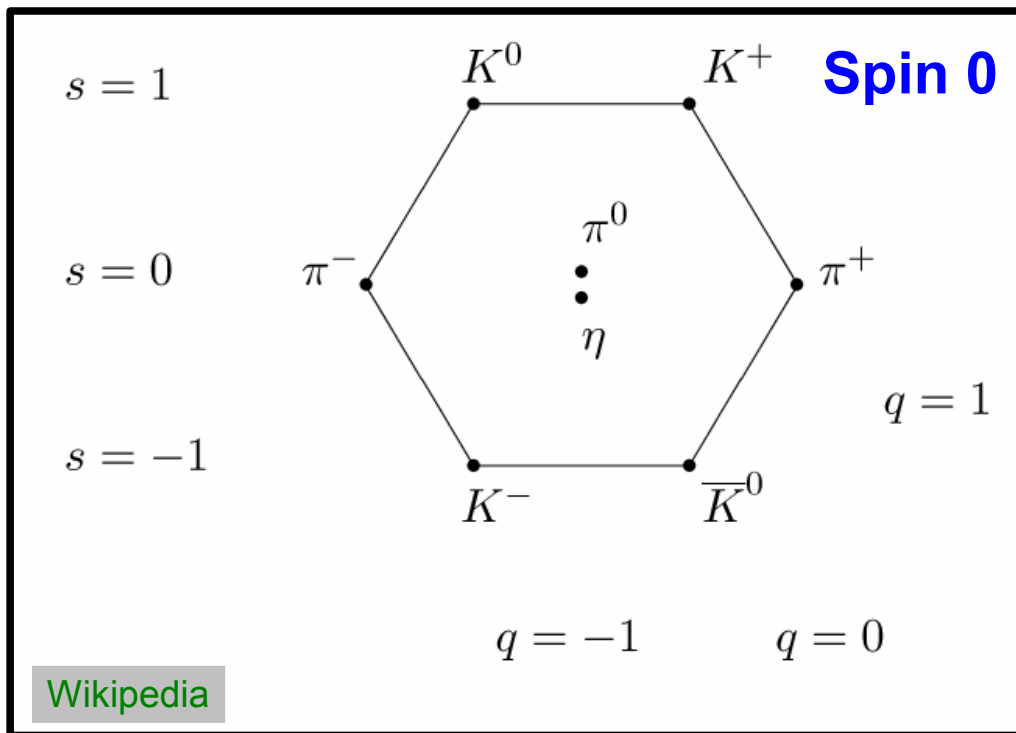

Problem 2: Scale Invariance

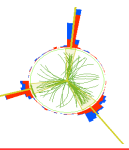

- Inelastic \gg elastic cross section
- Inelastic cross section $\sim \text{const.} * \text{Mott}$
- ➔ \sim independent of resolution $\sim q^2$
- ➔ scale invariant, i.e. no nat. length scale
- ➔ Scattering on point-like objects

Deep-inelastic scattering (DIS)

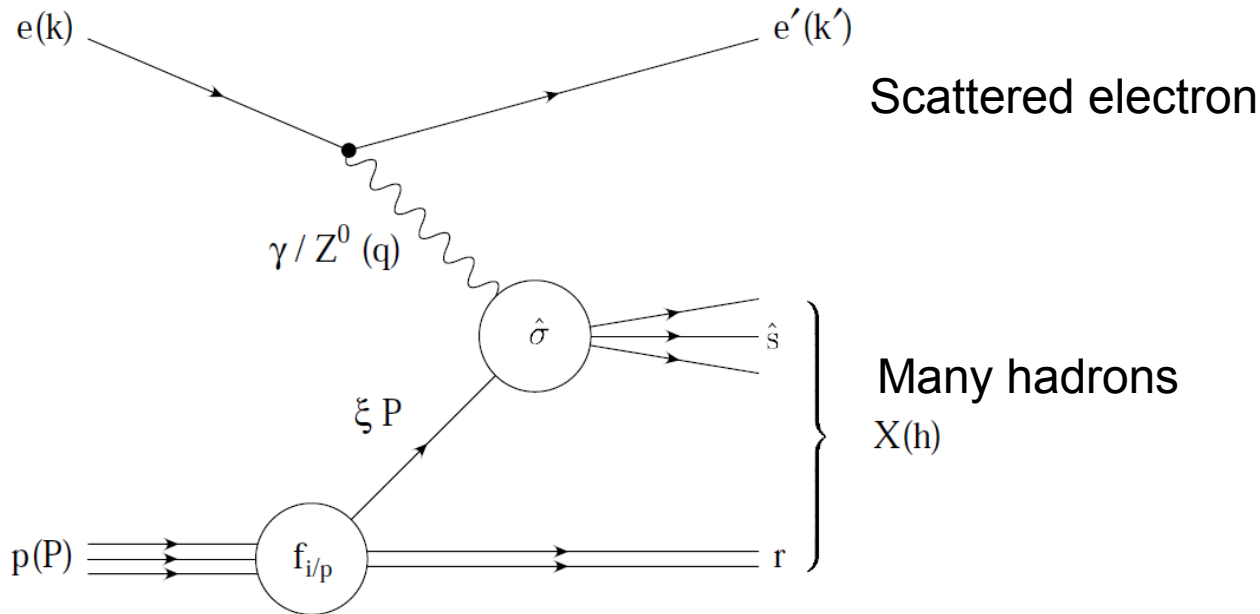

Elektron-Proton-Scattering

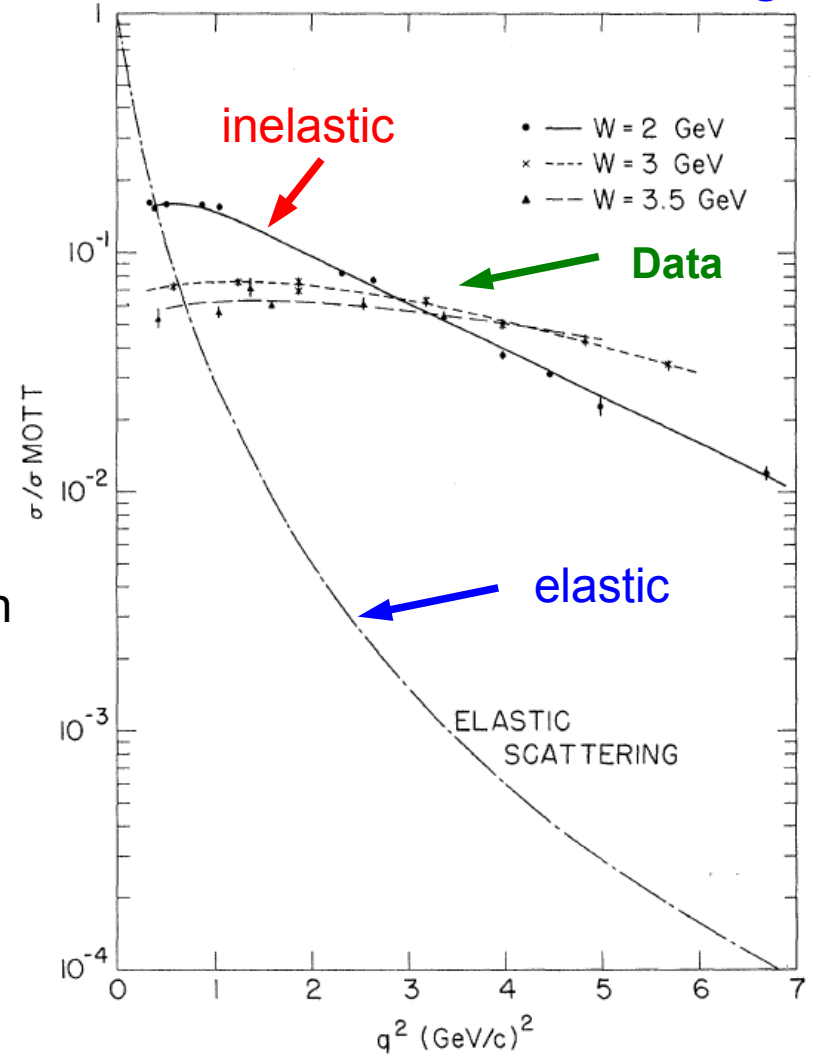

PRL 23 (1969) 935.

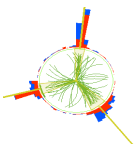

Quark-Parton-Model

- **M. Gell-Mann:** Zusammensetzung der Mesonen aus einem Quark-Antiquark-Paar und Baryonen aus drei Quarks (benannt nach Zitat aus J. Joyce "Finnegan's Wake": "Three quarks for Muster Mark.")
- **G. Zweig:** Analoge Idee, sein Name von "Aces" für die hypothetischen Bausteine setzte sich nicht durch.
 - ➔ Quarks/Aces nur als hypothetische mathematische Konstrukte gesehen, drittelzahlige Ladungen, wie hier nötig, wurden nie beobachtet
- **R. Feynman:** Erklärung der Messungen der tiefunelastischen Elektron-Proton-Streuung im SLAC-MIT Experiment mit punktförmigen Streuzentren im Innern der Protonen: Partonen
 - ➔ Später: Identifizierung der Partonen mit (Anti-)Quarks und Gluonen



Scienceworld



nobelprize.org



Nobel Prize 2004

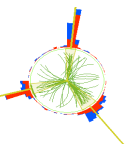

See again Bryan's talk yesterday:

- ➔ Renormierungsgruppengleichung
- ➔ Lösung der 1-Schleifen-Gleichung
- ➔ Laufende Kopplungskonstante

$$\alpha_s(Q^2) = \frac{\alpha_s(\mu^2)}{1 + \alpha_s(\mu^2)\beta_0 \ln\left(\frac{Q^2}{\mu^2}\right)}$$

$$\alpha_s(Q^2) = \frac{1}{\beta_0 \ln\left(\frac{Q^2}{\Lambda^2}\right)}$$

Was passiert bei grossen Abständen?

- ➔ $Q^2 \rightarrow 0$?
- ➔ Kann so nicht beantwortet werden, da für $Q^2 \rightarrow \Lambda^2$ perturbative Formeln nicht mehr anwendbar!

Siehe auch Artikel: Physik Journal 3 (2004) Nr. 12



- ➔ 'Starke' Kopplung schwach bei $Q^2 \rightarrow \infty$, d.h. kleinen Abständen
- ➔ **Asymptotische Freiheit**
- ➔ Perturbative Methoden anwendbar

$$\beta_0 = \frac{33 - 2 \cdot N_f}{12\pi}$$

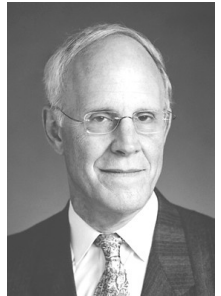

D. Gross



D. Politzer



F. Wilczek

nobelprize.org



Running Coupling

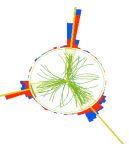

$$\alpha_s(Q^2) = \frac{1}{\beta_0 \ln\left(\frac{Q^2}{\mu^2}\right)}$$

mit Λ typischerweise $\approx 200 - 300 \text{ MeV}$

Nicht-perturbativer Bereich

QCD Potential wächst linear bei grossen Abständen:

$$V = \sigma \cdot r \approx 1 \text{ GeV/fm} \cdot r$$

→ Keine freien Quarks (oder Gluonen)

→ Confinement

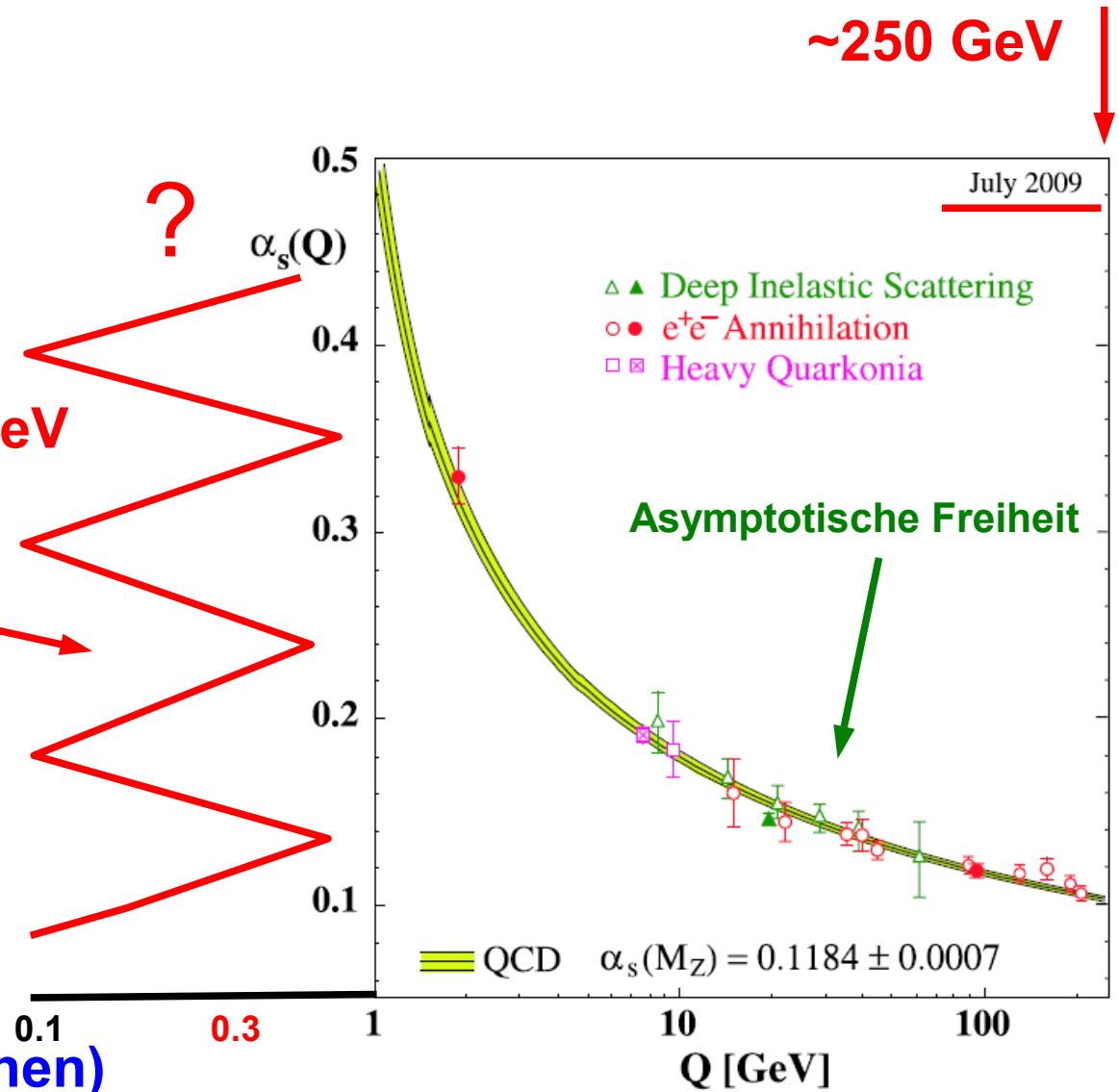

S. Bethke, EPJC 64 (2009).

Factorized Cross Section

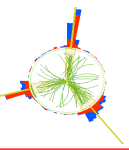

Let's have a look at the formula again:

$$\sigma_{pp \rightarrow X} = \sum_{ijk} \int dx_1 dx_2 dz f_i(x_1, \mu) f_j(x_2, \mu) \times \hat{\sigma}_{ij \rightarrow k}(x_1, x_2, z, Q^2, \alpha_s(\mu), \mu) D_{k \rightarrow X}(z, \mu)$$

PDFs describing initial state hadrons

Hard cross section calculable in pQCD
→ but limitations on observables!

Same trick for final state:
Fragmentation Function

And we observe particles in our detectors and not partons! → ways out:

Forget about uncalculable details and define proper observable insensitive to nonperturbative phase
→ JETS



Event Display from Theory

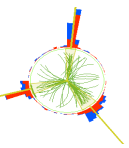

S. Gieseke

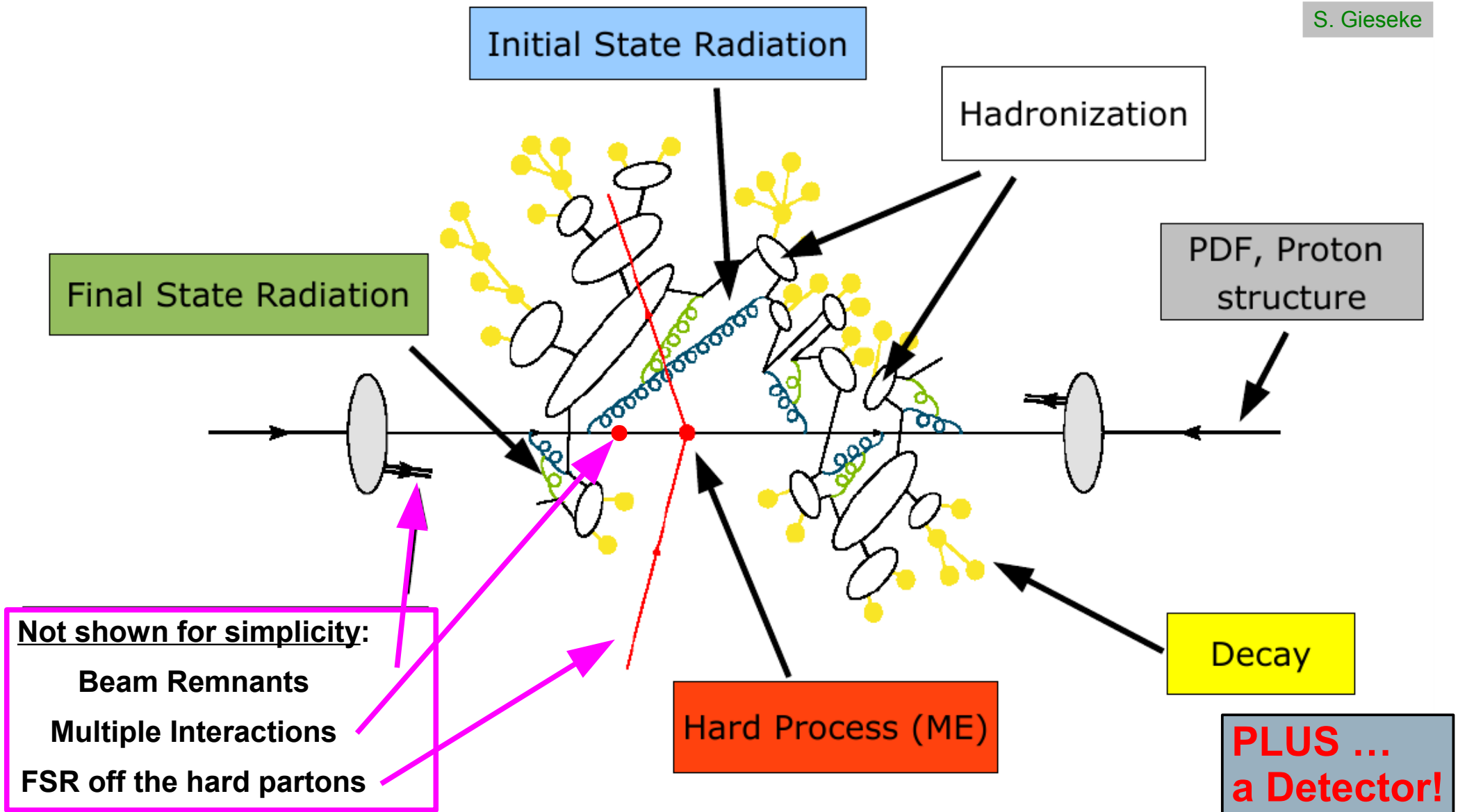

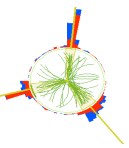

First indications of “gluon” production ...

PLUTO @ PETRA, 1979

$\sqrt{s} = 27.7 - 30 \text{ GeV}$

$$e^+e^- \rightarrow qqg$$

... but not as a free particle

and which one is it?

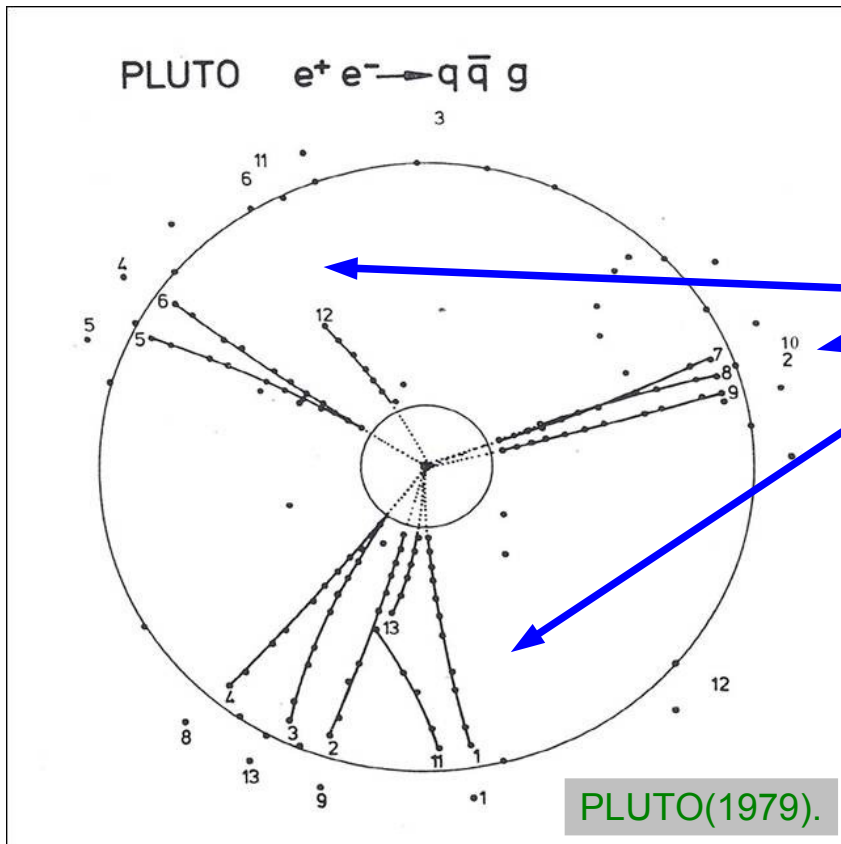

- Collimated bundle of particles with
- + Small rel. transverse momenta ($\sim \Lambda$) in comparison to primary direction



The UA2 Experiment

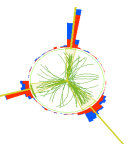

p- \bar{p} experiment UA2

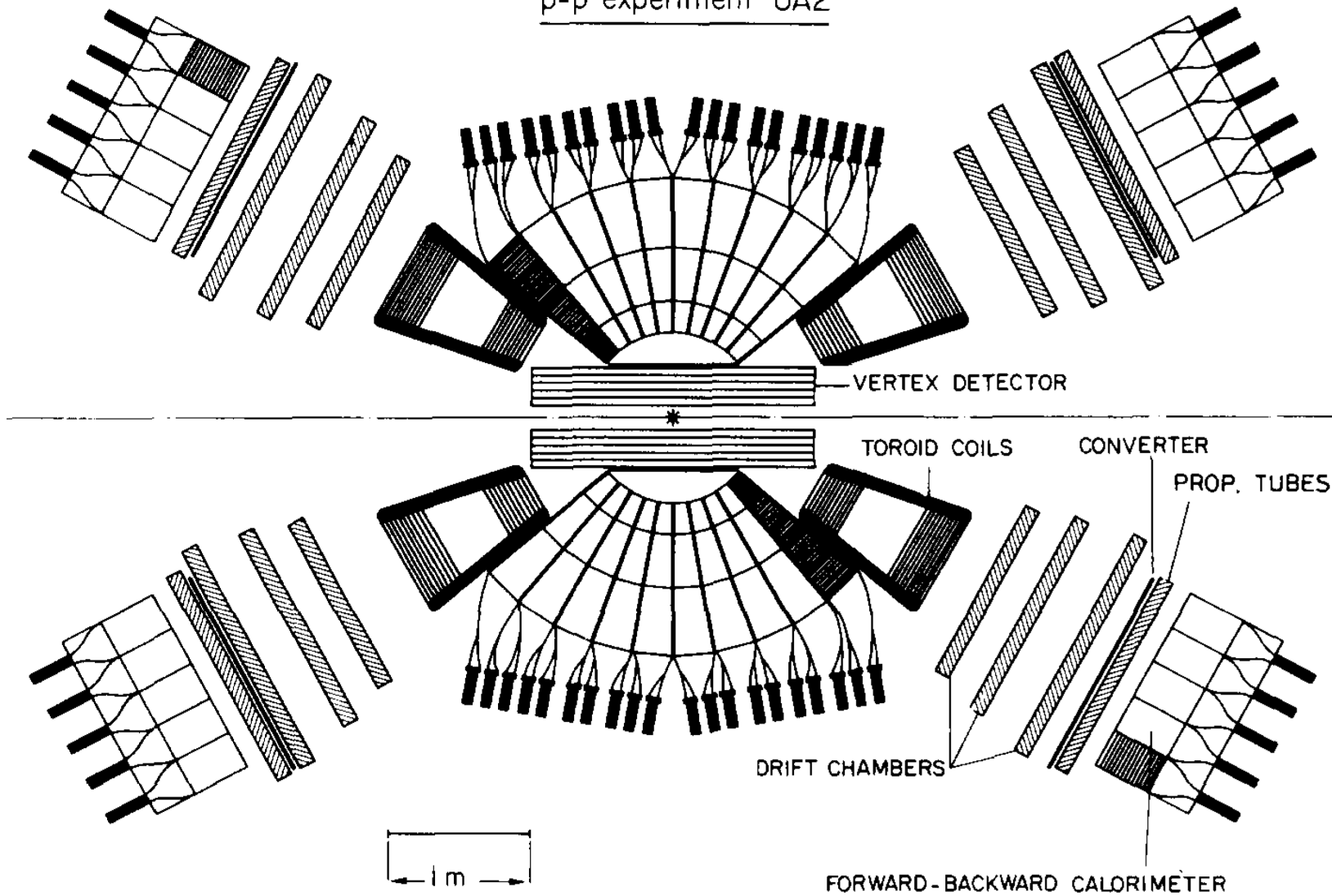

$\sqrt{s} = 540 \text{ GeV}$
Jet $p_T \rightarrow 60 \text{ GeV}$

UA2, PLB 118 (1982).



First Jets in hadronic Collisions

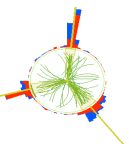

Dijet event with clearly separated energy depositions

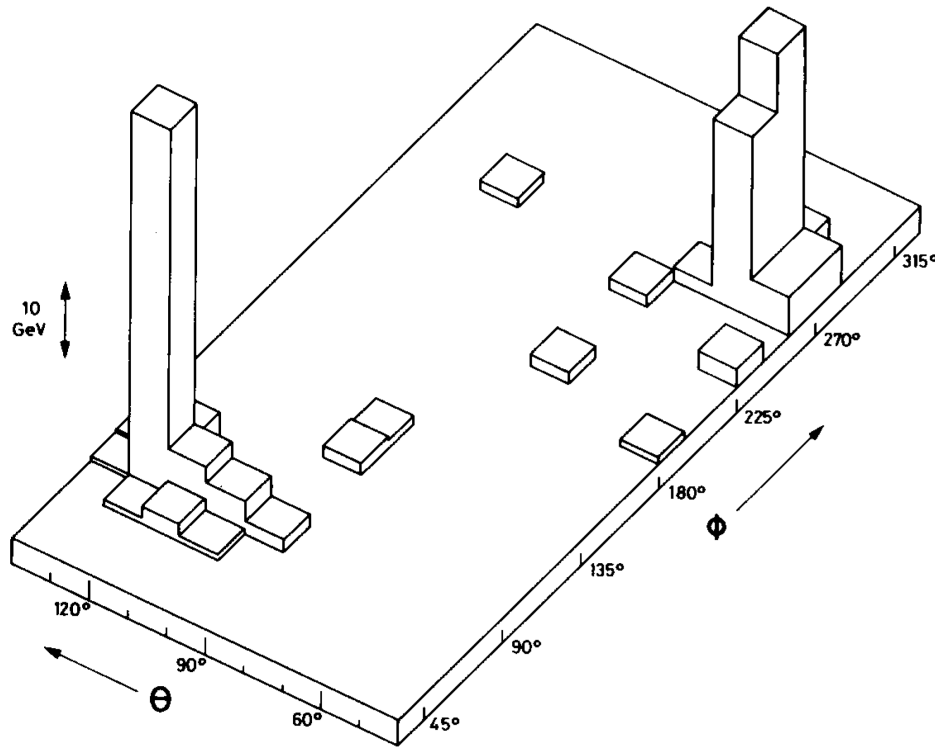

'Jet-Algorithm' based on cellular structure of calorimeters (UA1 & UA2)
UA1 later used cone-type jet algorithm!

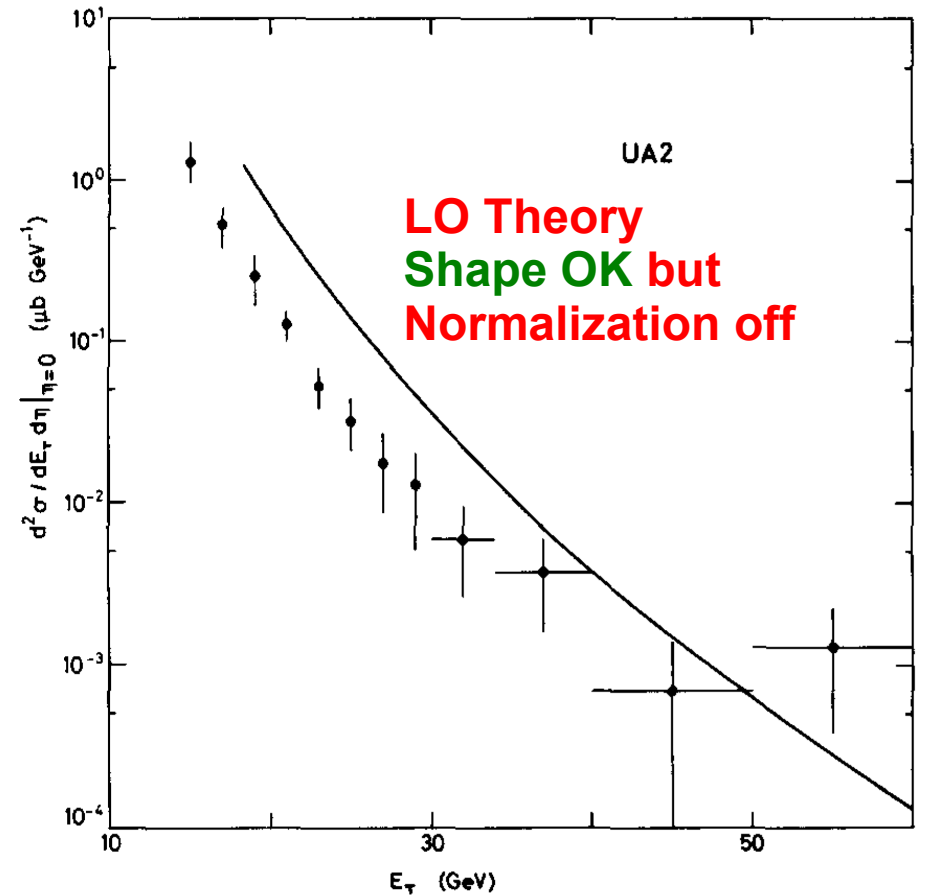
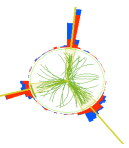

Fig. 6. Inclusive jet production cross section. The solid line (ref. [6]) uses $\Lambda = 0.5$ GeV while $\Lambda = 0.15$ GeV would bring the calculated rates in better agreement with the data. However various uncertainties preclude a determination of Λ from the data [13].

UA2, PLB 118 (1982).



3-Jet Events 1979 – 2010



Jets clearer visible ... but what belongs where?

PLUTO, 1979
 e^+e^- , $\sqrt{s} = 30 \text{ GeV}$
Multiplicity ~ 10

CMS, 2010
 pp , $\sqrt{s} = 7000 \text{ GeV}$
Multiplicity ~ 100

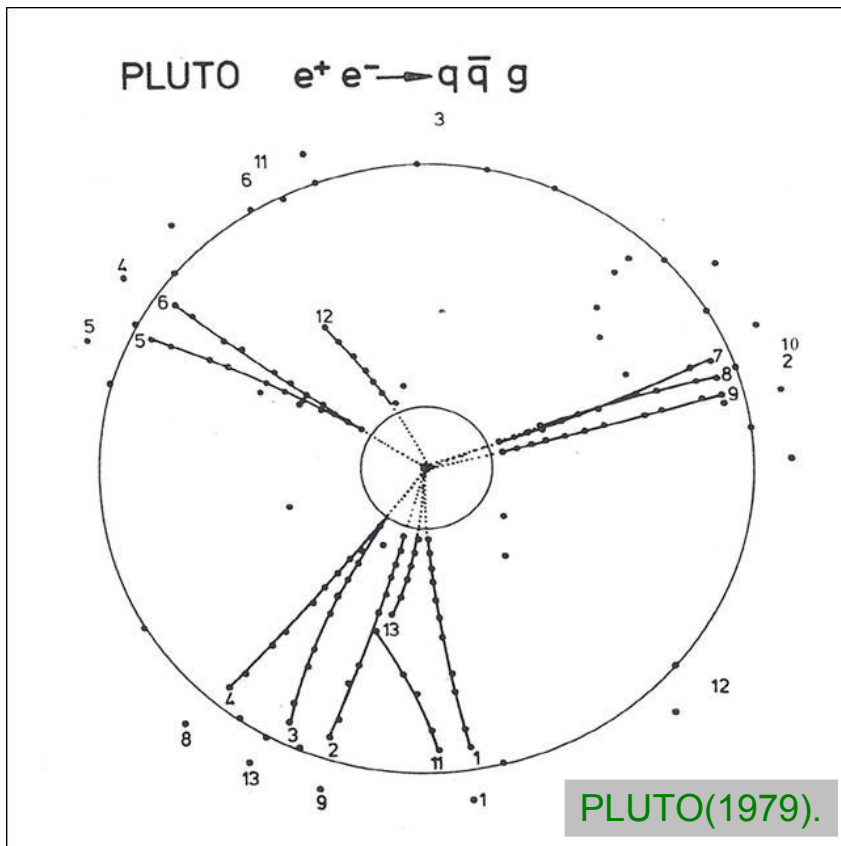

Which Jet?

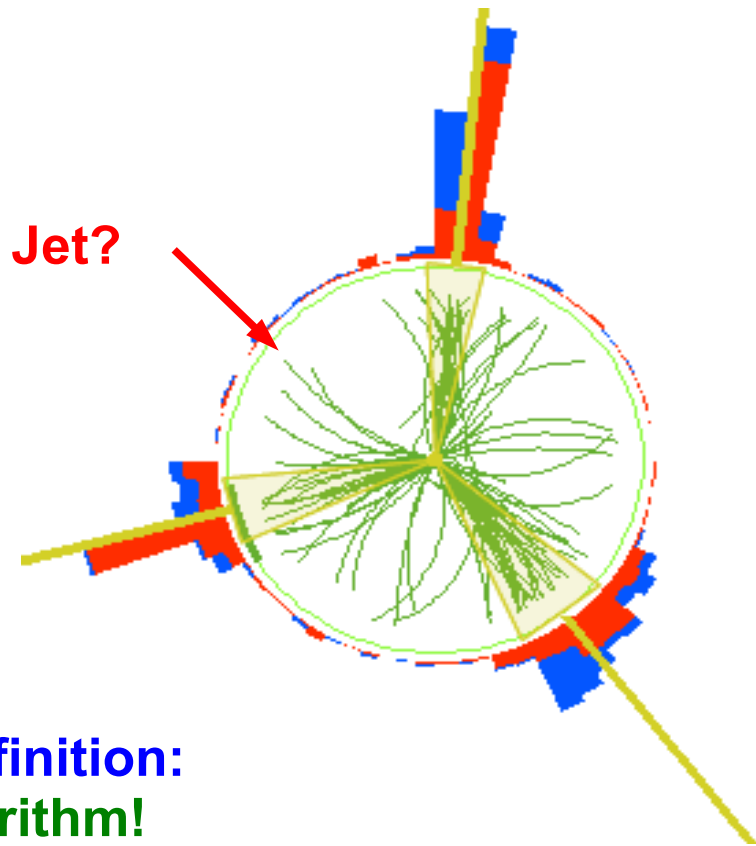

Need definition:
Jet-Algorithm!



Cone Algorithm

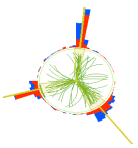

- **Erste Definition von G. Serman, und S. Weinberg, PRL 39 (1977):**
 - ➔ Speziell für Zweijet-Produktion in e^+e^- mit gegenüberliegendem Doppelkonus
 - ➔ Theoretisch 'wohldefiniert' in Störungstheorie, vermeidet Probleme mit Singularitäten
 - ➔
- **UA1 Kollaboration am CERN SppS, PLB 123 (1982):**
 - ➔ Cluster-Algorithmus um Zellen mit mehr als 2.5 GeV Energie ('Seed')
 - ➔ Abstandskriterium in (Pseudo-)Rapidity und Azimutalwinkel zur Zelle (oder zum Jet)
→ Konus (geometrisch: Kegel) im (Φ, η) -Raum
 - ➔ 4-Vektoraddition zum Zusammenfassen
 - ➔ Weitere Kriterien energieärmere Zellen hinzuzufügen

$$R = \sqrt{(\Delta\phi)^2 + (\Delta\eta)^2}$$

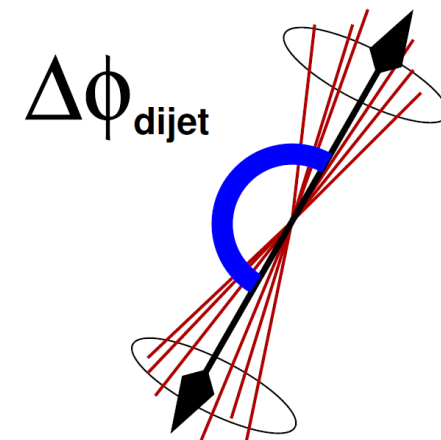

M. Wobisch

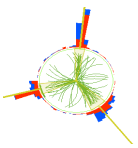

● JADE Kollaboration am DESY PETRA, ZPhysC 33 (1986):

- ➔ Algorithmus mit sequentieller Rekombination
- ➔ 1. Definiere Abstandsmetrik zwischen zwei Objekten i und j über ihre Vierer-Vektoren
- ➔ 2. Berechne die Abstände aller paarweisen Kombinationen i, j
- ➔ 3. Vergleich den kleinsten Abstand mit einem Schwellwert y_{cut}
- ➔ 4. Falls kleiner → Kombiniere beide Objekte i, j zu einem neuen → Iteriere bei Schritt 2
- ➔ 5. Falls grösser → Stoppe Algorithmus und erkläre alle verbliebenen Vierer-Vektoren zu Jets!

$$j_{ij}^J = \frac{2E_i E_j (1 - \cos(\theta_{ij}))}{E_{\text{vis}}^2}$$

$$y_{i,j;\text{min}} < y_{\text{cut}}$$

A bit personal History

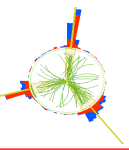

The very first physics conference I went to just starting my Diploma thesis 1992:

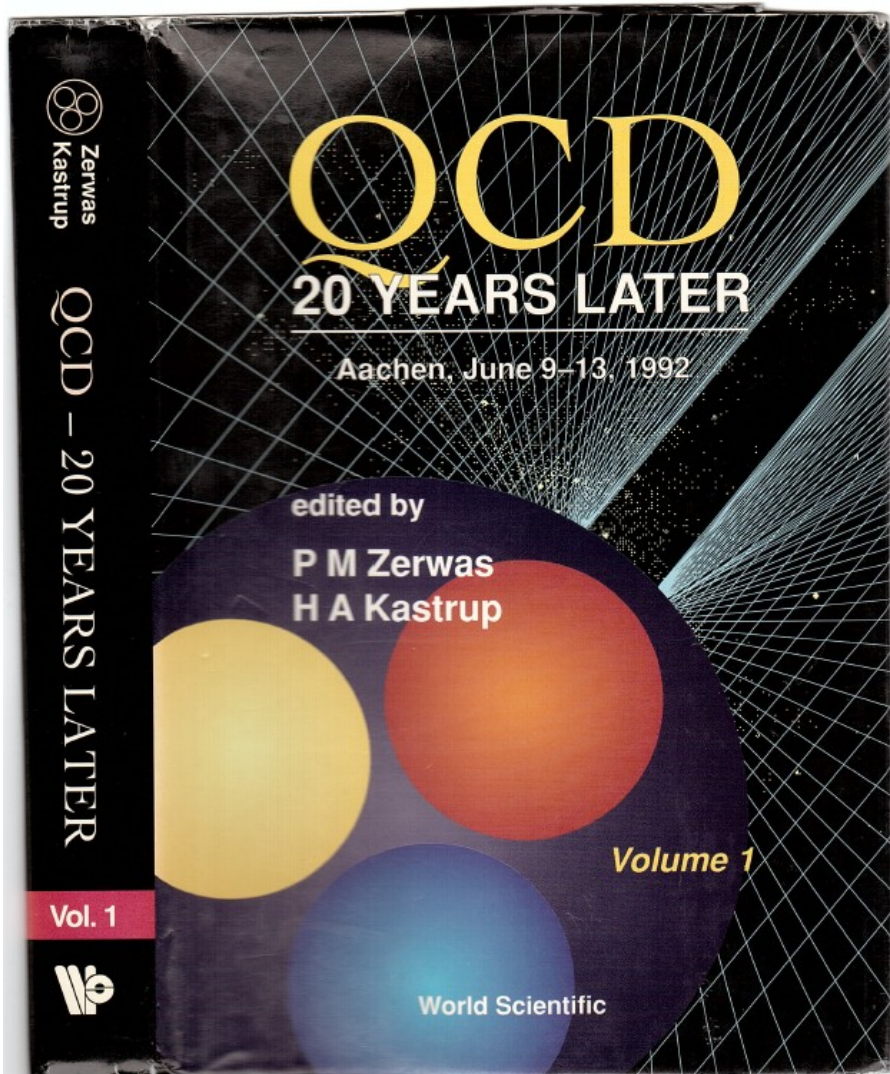

Didn't understand overly much ... still remember Borel sums ... confirming my prejudice of total Incomprehensibility ... apart from one talk that caught my attention:

JETS IN PERTURBATION THEORY

B.R. Webber⁺)

Theoretical Physics Division, CERN
CH - 1211 Geneva 23



JADE vs. k_t Algorithm

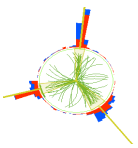

Attributed to same JADE jet leads to

- larger hadronization corrections
- non-resummability

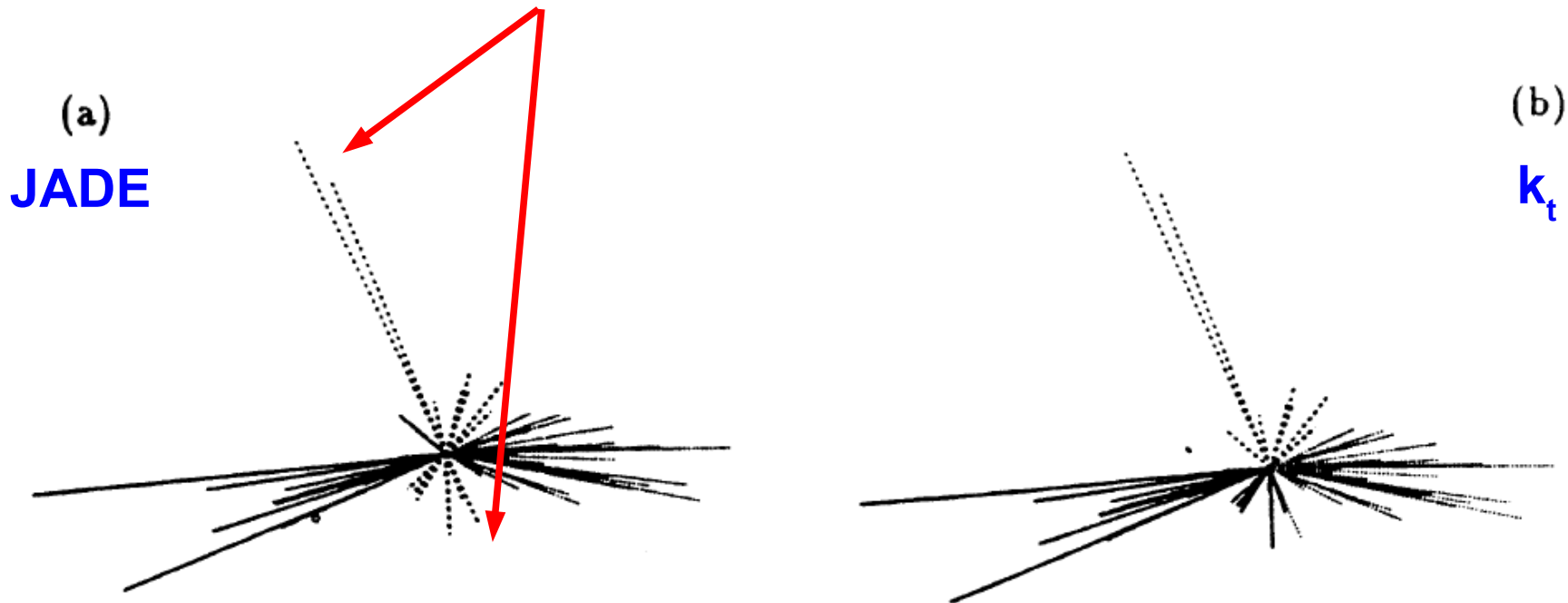
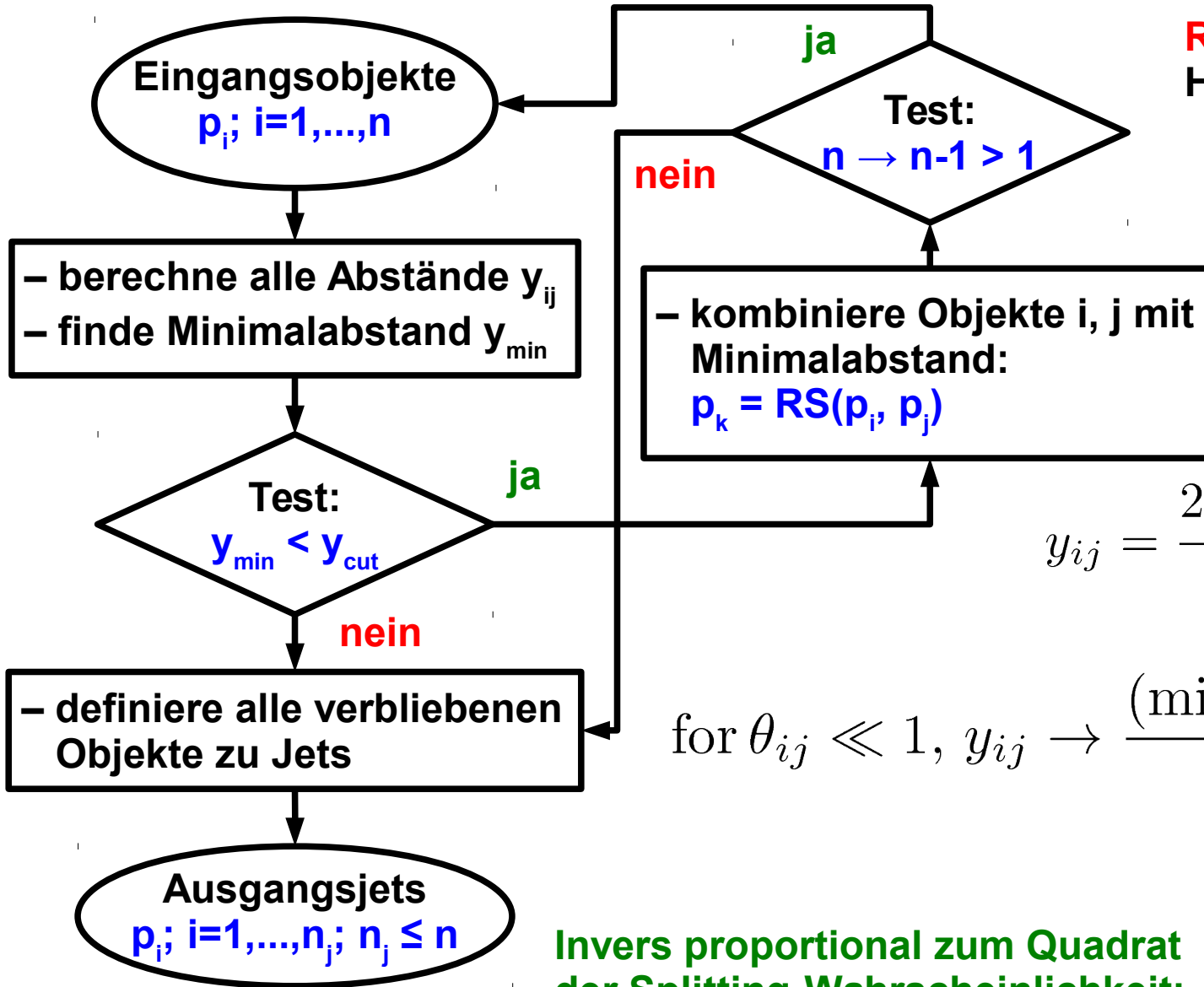
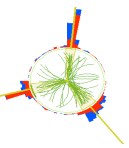

Figure 4: A three-jet final state and the assignment of particles to the first (solid), second (dotted) and third (dashed) jets according to the (a) JADE and (b) k_t algorithms.



k_T Algorithmus – e^+e^-



RS = Rekombinationsschema
 Hier: 4-Vektoraddition: $p_k = p_i + p_j$

Catani, Dokshitzer, Olsson, Turnock, Webber, PLB 269 (1991).

$$y_{ij} = \frac{2 \min(E_i^2, E_j^2)(1 - \cos(\theta_{ij}))}{E_{\text{vis}}^2}$$

$$\text{for } \theta_{ij} \ll 1, y_{ij} \rightarrow \frac{(\min(E_i, E_j) \theta_{ij})^2}{E_{\text{vis}}^2} = \frac{k_T^2}{E_{\text{vis}}^2}$$

Invers proportional zum Quadrat der Splitting-Wahrscheinlichkeit:

$$\frac{dP_{k \rightarrow ij}}{dE_i d\theta_{ij}} \approx \frac{\alpha_s}{\min(E_i, E_j) \theta_{ij}}$$

Inclusive $k_T - hh$

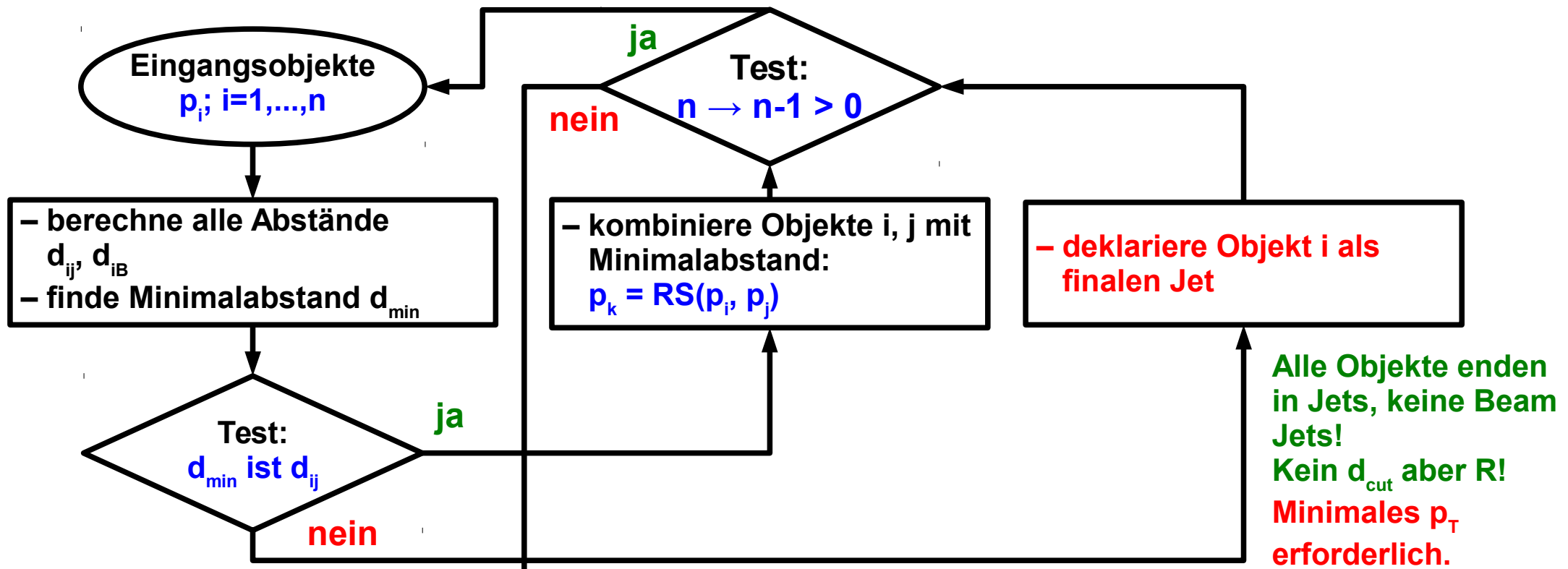
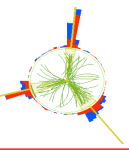

$$d_{ij} = \min(p_{T,i}^2, p_{T,j}^2) \frac{\Delta R_{ij}^2}{R^2}$$

$$d_{iB} = p_{T,i}^2 \quad \Delta R_{ij}^2 = (y_i - y_j)^2 + (\phi_i - \phi_j)^2$$

RS: 4-Vektoraddition: $\mathbf{p}_k = \mathbf{p}_i + \mathbf{p}_j$

Ellis, Soper, PRD 48, (1993).

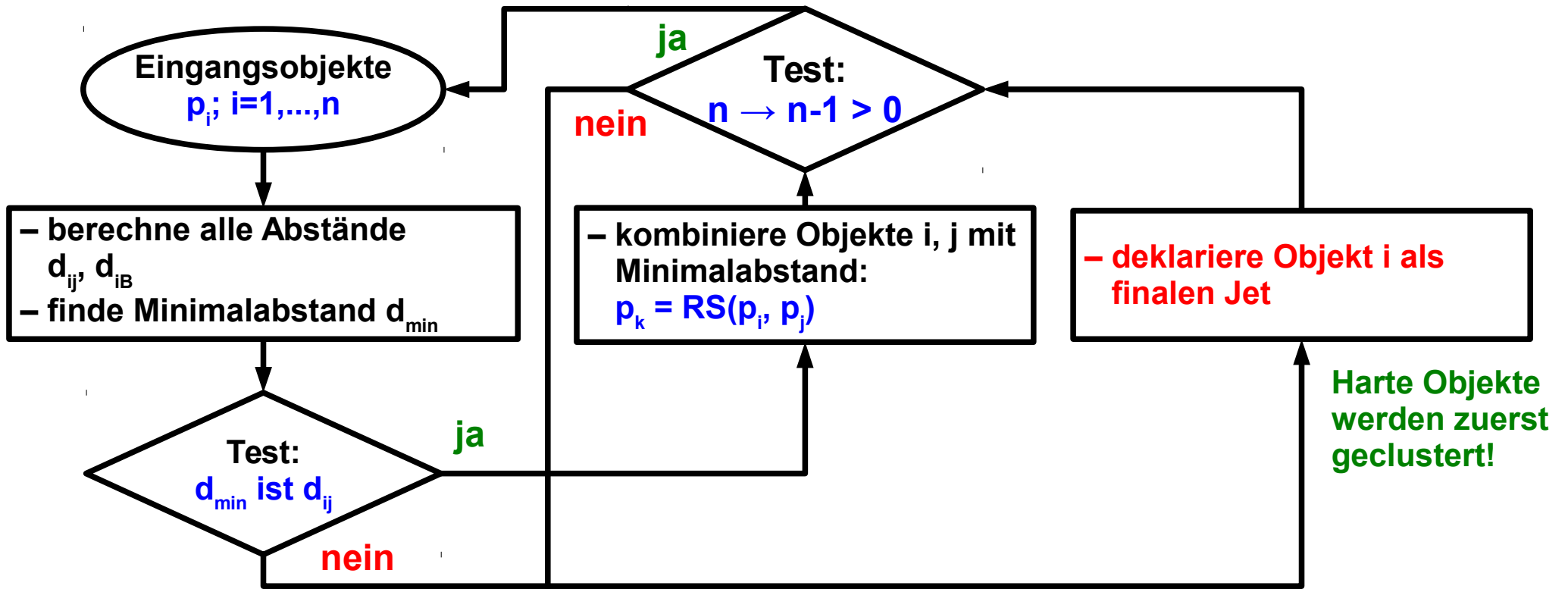
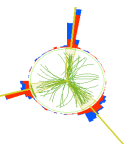

$$d_{ij} = \min \left(p_{T,i}^{-2}, p_{T,j}^{-2} \right) \frac{\Delta R_{ij}^2}{R^2}$$

$$d_{iB} = p_{T,i}^{-2} \quad \Delta R_{ij}^2 = (y_i - y_j)^2 + (\phi_i - \phi_j)^2$$

RS: 4-Vektoraddition: $p_k = p_i + p_j$ Cacciari, Salam, Soyez, JHEP04 (2008).



Jet Algorithms

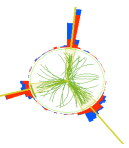

Primary Goal:

Establish a good correspondence between:

- detector measurements
- final state particles and
- hard partons

Two classes of algorithms:

1. Cone algorithms: "Geometrically" assign objects to the leading energy flow objects in an event (favorite choice at **hadron colliders**)
2. Sequential recombination: Repeatedly combine closest pairs of objects (favorite choice at **e^+e^- & ep colliders**)

Standard at LHC: anti-kT

Type 2 algorithm that looks like Type 1!

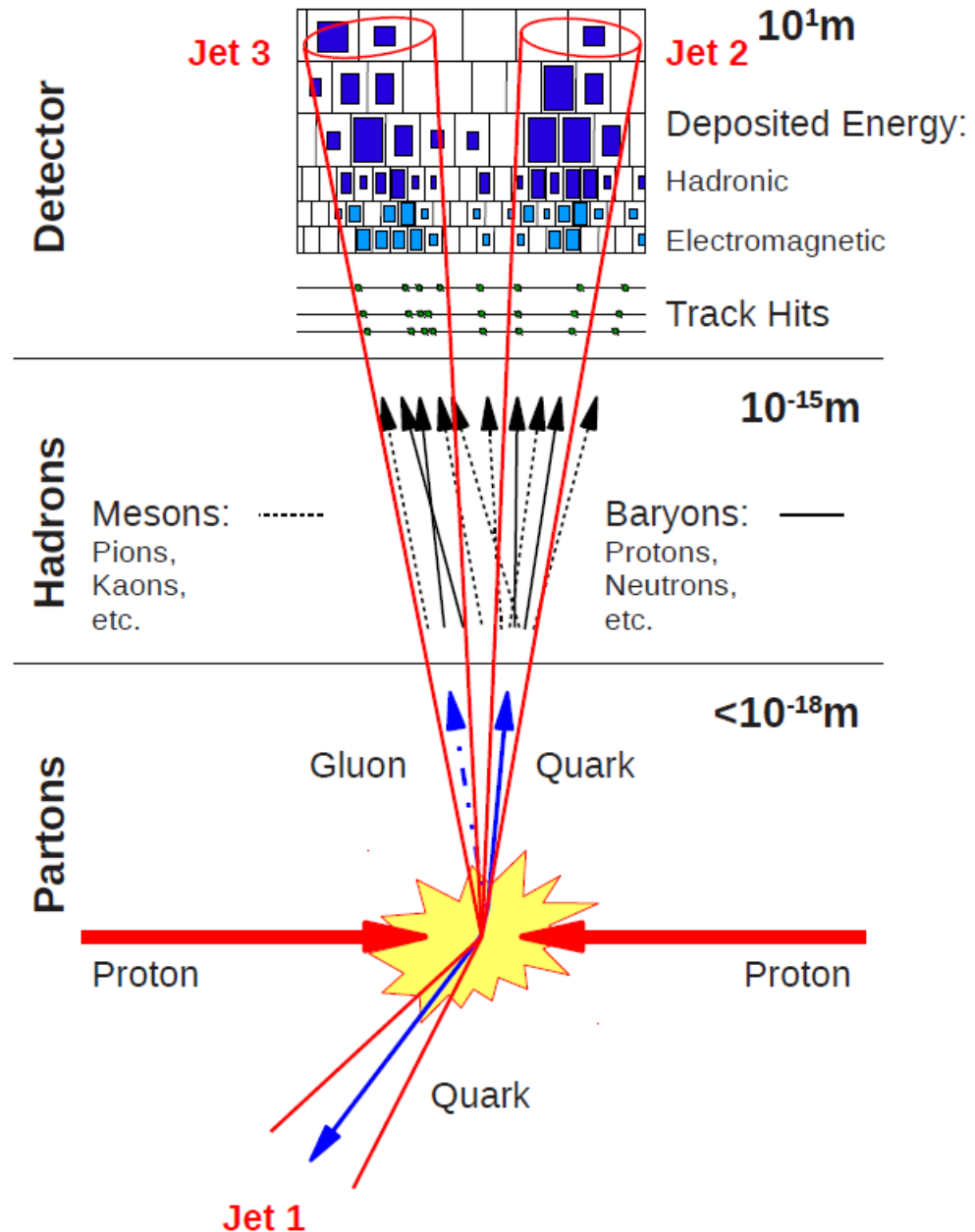



Jet Algorithms 2

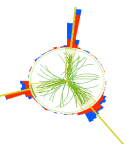

● Jet Algorithm Desiderata (Theory):

- ➔ **Infrared safety**
- ➔ **Collinear safety**
- ➔ **Longitudinal boost invariance**
(recombination scheme!)
- ➔ **Boundary stability**
(→ 4-vector addition, rapidity y)
- ➔ **Order independence**
(parton, particle, detector)
- ➔ **Ease of implementation**
(standardized public code?)

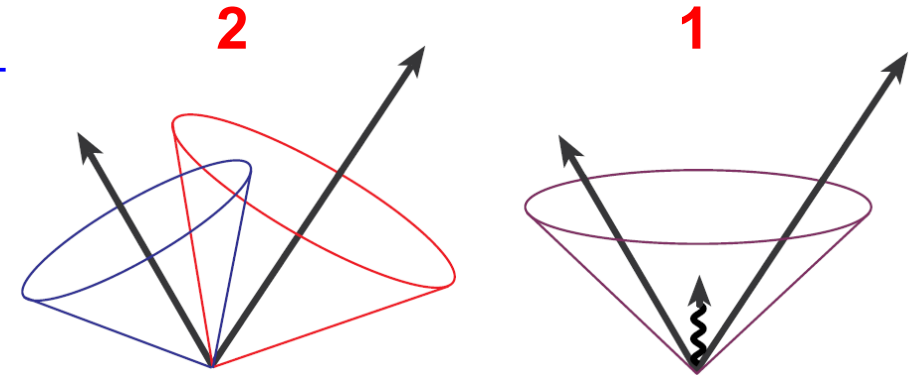

IR unsafe: Sensitive to the addition of soft particles

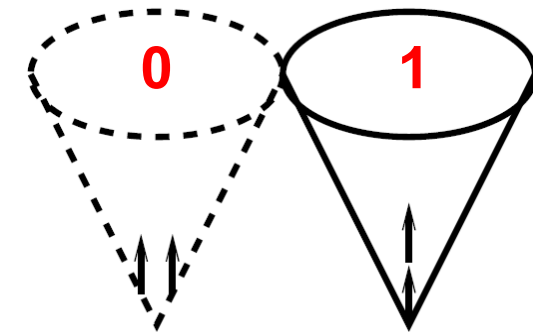

Coll. unsafe: Sensitive to the splitting of a 4-vector (seeds!)

See also:

“Snowmass Accord”, FNAL-C-90-249-E

Tevatron Run II Jet Physics, hep-ex/0005012

Les Houches 2007 Tools and Jets Summary , arXiv:0803.0678

Jet Algorithms 3

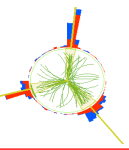

Jet Algorithm Desiderata (Experiment):

- **Computational efficiency and predictability**
(use in trigger?, reconstruction times?)
- **Maximal reconstruction efficiency**
- **Minimal resolution smearing and angular biasing**
- **Insensitivity to pile-up**
(mult. collisions at high luminosity ...)
- **Ease of calibration**
- **Detector independence**
- **Fully specified**
(details?, code?)
- **Ease of implementation**
(standardized public code?)

$$d_{ij} = \min(k_{ti}^{2p}, k_{tj}^{2p}) \frac{\Delta_{ij}^2}{R^2}$$

$$d_{iB} = k_{ti}^{2p},$$

$$\Delta_{ij}^2 = (y_i - y_j)^2 + (\phi_i - \phi_j)^2$$

p = 1: kT

p = 0: Cambridge/Aachen

p = -1: anti-kT

Original kT implementation

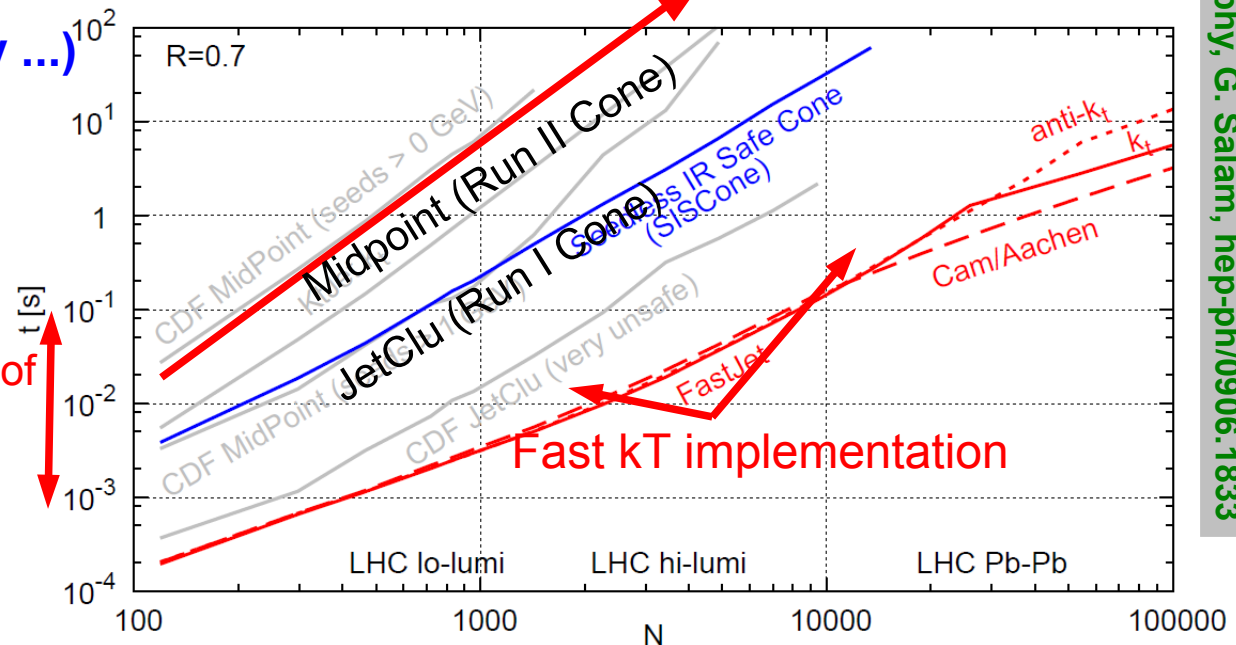



Jet Algorithms at LHC

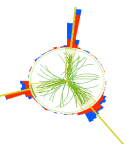

Primary algorithm at LHC:

→ Anti- k_T :

ATLAS R = 0.4, 0.6

CMS R = 0.5, 0.7

→ k_T

→ SIS Cone (“real” cone algo)

→ Cambridge/Aachen

used in jet substructure, for example in boosted top

General interest to work with all four!

Only “real” cone Algorithm left!

k_T hh, Ellis, Soper, PRD48 (1993),
Cam/AC, Dokshitzer et al., JHEP08 (1997),
Wobisch, Wengler, arXiv:hep-ph/9907280,
SIS Cone, Salam, Soyez, JHEP05 (2007)
Fast *k_T*, Cacciari/Salam, PLB641, 2006
SIS Cone, Salam/Soyez, JHEP05, 2007
anti-*k_T*, Cacciari et al., JHEP04, 2008

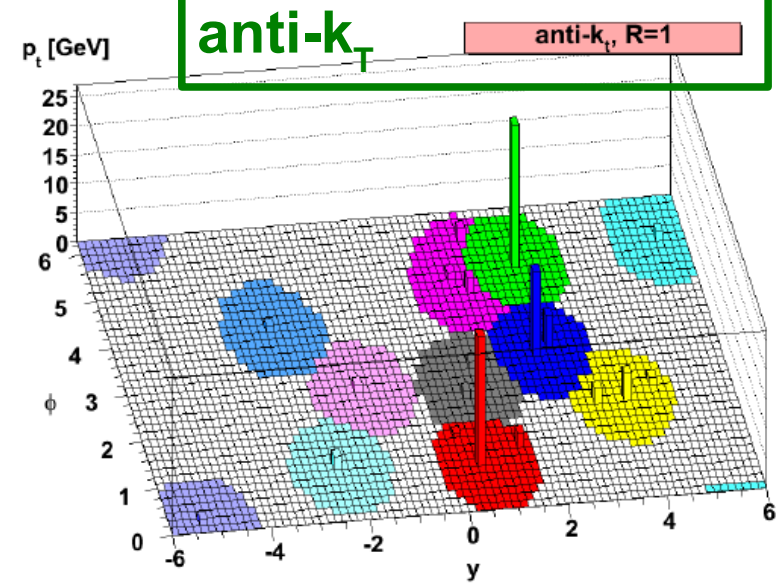
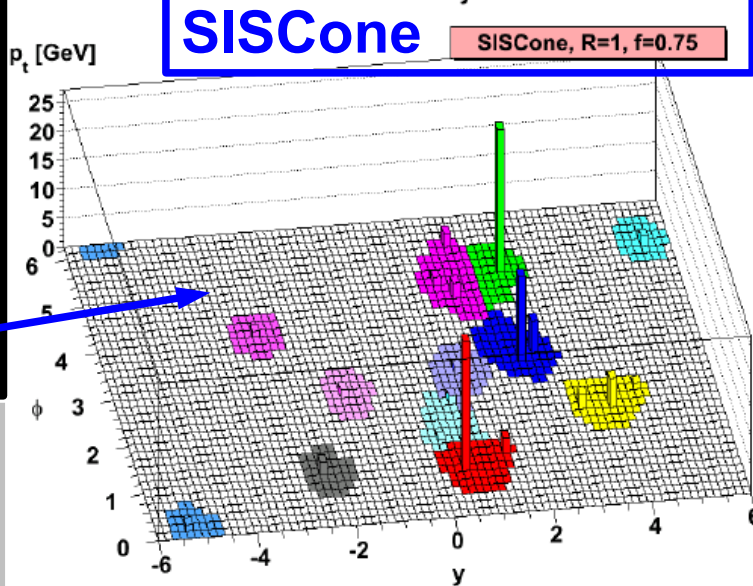
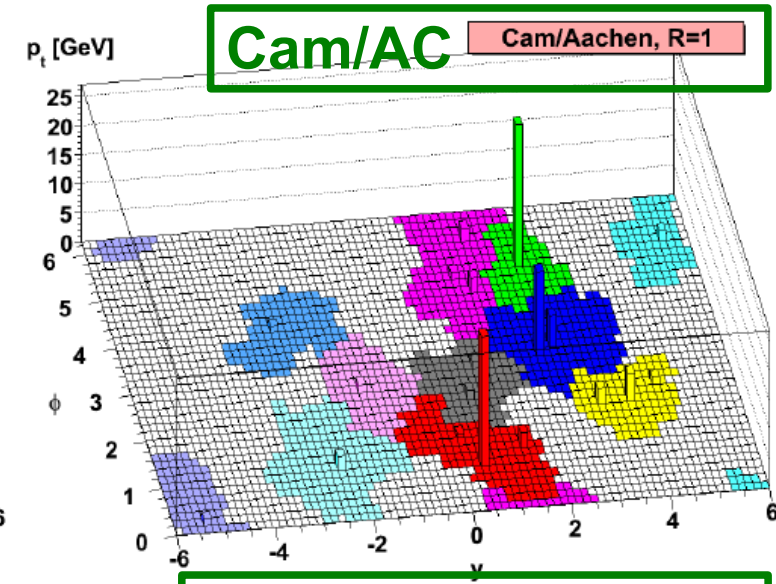
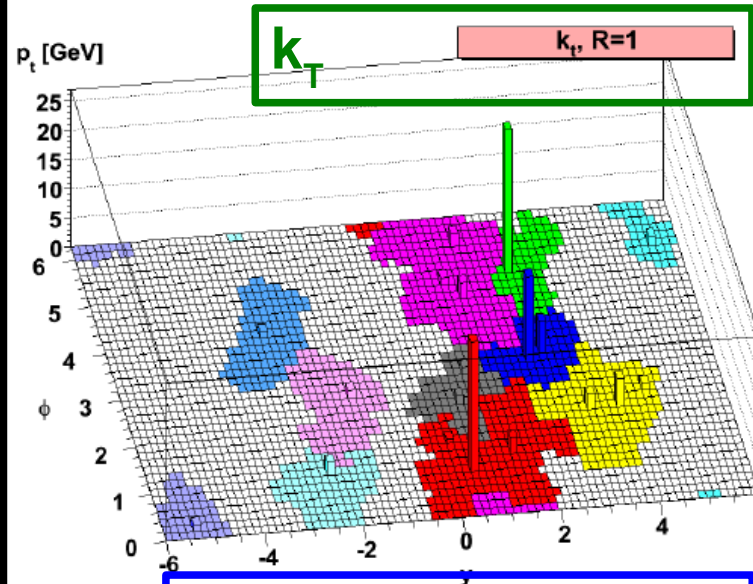



Jet Algo Desiderata --- Today

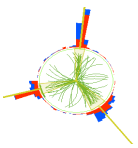

Theory:

- ➔ **Infrared safety**
- ➔ **Collinear safety**
- ➔ **Longitudinal boost invariance**
(recombination scheme!)
- ➔ **Boundary stability**
(→ 4-vector addition, rapidity y)
- ➔ **Order independence**
(parton, particle, detector)
- ➔ **Ease of implementation**
(standardized public code: fastjet)

**Many of these points were red,
i.e. not fulfilled, in times just
before the LHC!**

Experiment:

- ➔ **Ease of calibration**
- ➔ **Insensitivity to pile-up**
- ➔ **Minimal resolution smearing and angular biasing**
- ➔ **Maximal reconstruction efficiency**
- ➔ **Computational efficiency and predictability**
(use in reconstruction, trigger)
- ➔ **Detector independence**
- ➔ **Fully specified**
(fastjet) Cacciari et al., EPJC72 (2012).
- ➔ **Ease of implementation**
(standardized public code: fastjet)



Jet Analysis Uncertainties

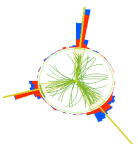

● Experimental Uncertainties (~ in order of importance):

- ➔ **Jet Energy Scale (JES)**
 - ➔ Noise Treatment
 - ➔ **Pile-Up Treatment**
- ➔ Luminosity (2 - 4%)
- ➔ **Jet Energy Resolution (JER)**
- ➔ Trigger Efficiencies
- ➔ Resolution in Rapidity
- ➔ Resolution in Azimuth
- ➔ Non-Collision Background
- ➔ ...

● Theoretical Uncertainties:

- ➔ **pQCD (Scale) Dependence**
- ➔ **PDF Uncertainty**
- ➔ **Non-perturbative Corrections**
- ➔ **PDF Parameterization**
- ➔ **NLO-NLL matching schemes**
- ➔ **Electroweak Corrections**
- ➔ **Knowledge of $\alpha_s(M_Z)$**
- ➔ ...



Jet Energy Scale

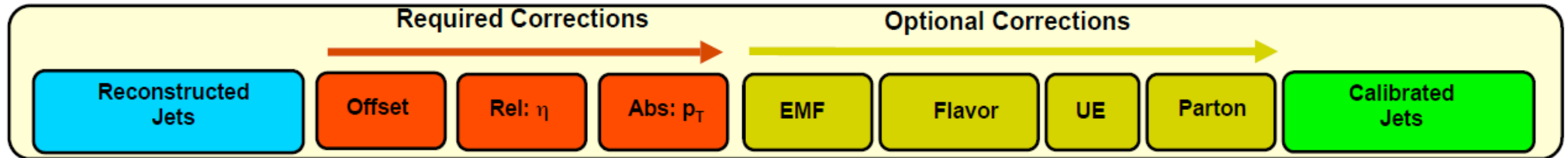
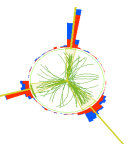

à la CMS

- ➔ **Offset:** Korrektur auf elektr. Rauschen und “**Pile-up**”
- ➔ **Relativ (η):** Ausgleich der Unterschiede in Jet-Antwort des Det. vs η
(Zweijet-Balance in p_T aus Daten oder MC Simulation)
- ➔ **Absolut (p_T):** Korrektur des gem. Jet p_T zu Teilchenjet p_T
(p_T Balance in Photon + 1Jet, Z + 1Jet Ereignissen)
- ➔ **Optionale weitere Korrekturen, analyseabhängig:** Jet Flavour, ...
- ➔ **Anfängliche Annahmen bei LHC Start:**

CMS Kalorimeter:	10%
ATLAS Kalorimeter:	7%
CMS Kalo & Spuren:	5%



“Particle Flow” Concept

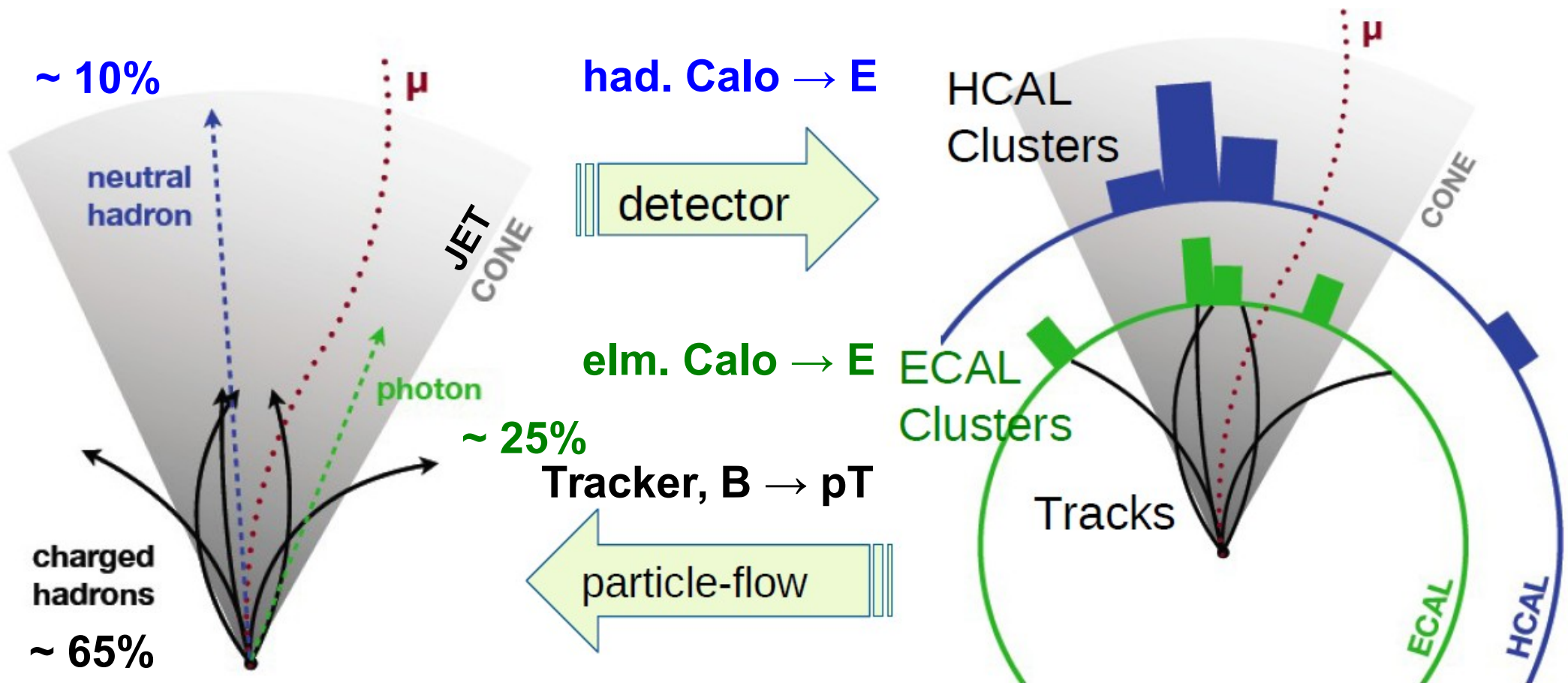
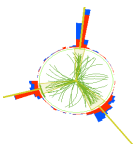

- ➔ **Combines measurements of different detector components**
- ➔ **Accounts for specific detector properties with respect to particle type**
- ➔ **Need appropriate MC event generators for simulations!**

Offset Correction

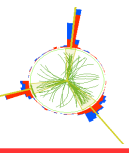

Tracking only
up to here

(Pile-Up:
Additional proton-proton-
Collisions in the same or
adjacent bunch crossing as the
triggering event)

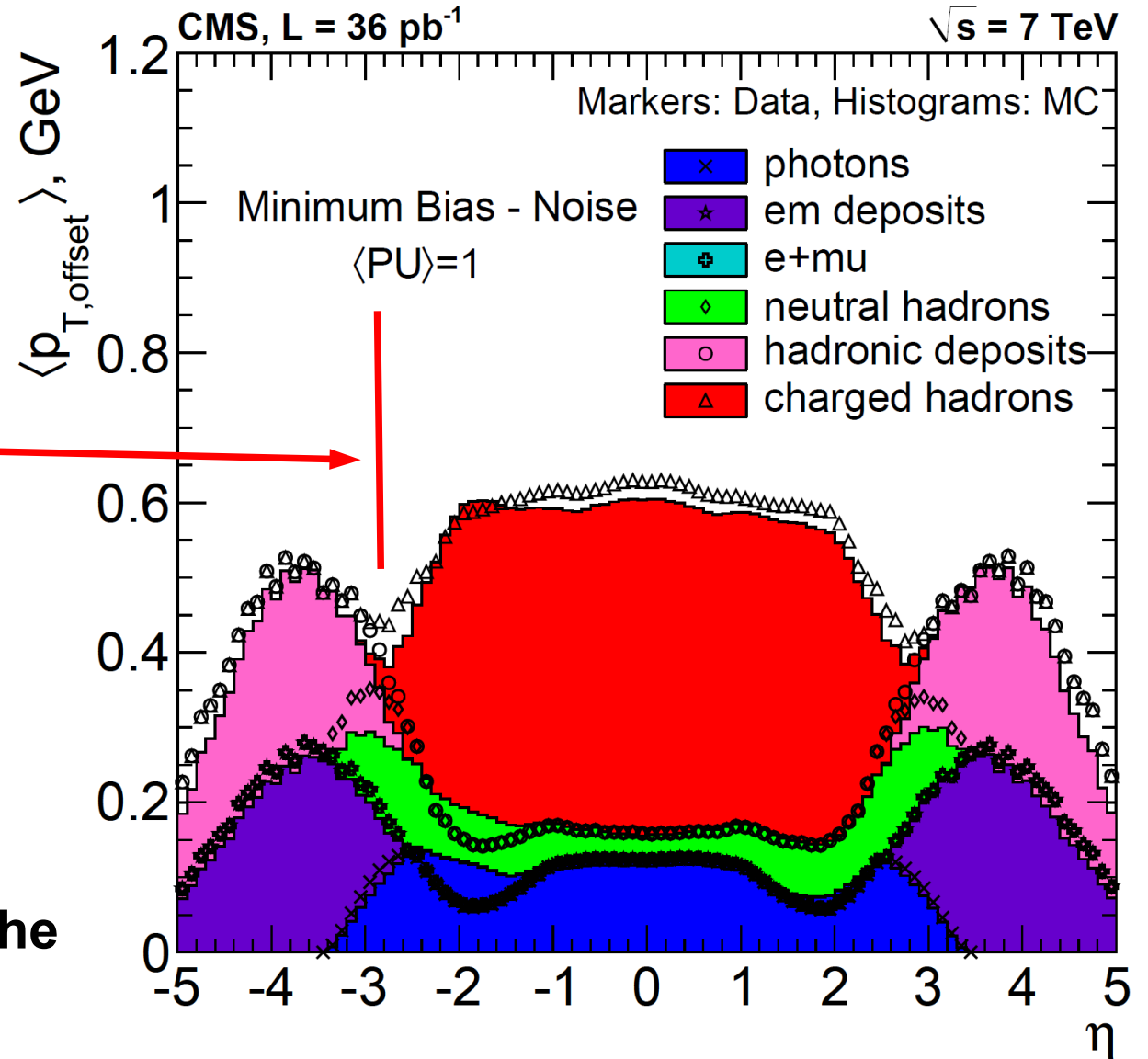

Offset correction per pileup

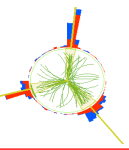

Approximately linear rise with number of primary vertices, here up to 8
Deviations from this behaviour for more pileup like in 2012 or 2015!

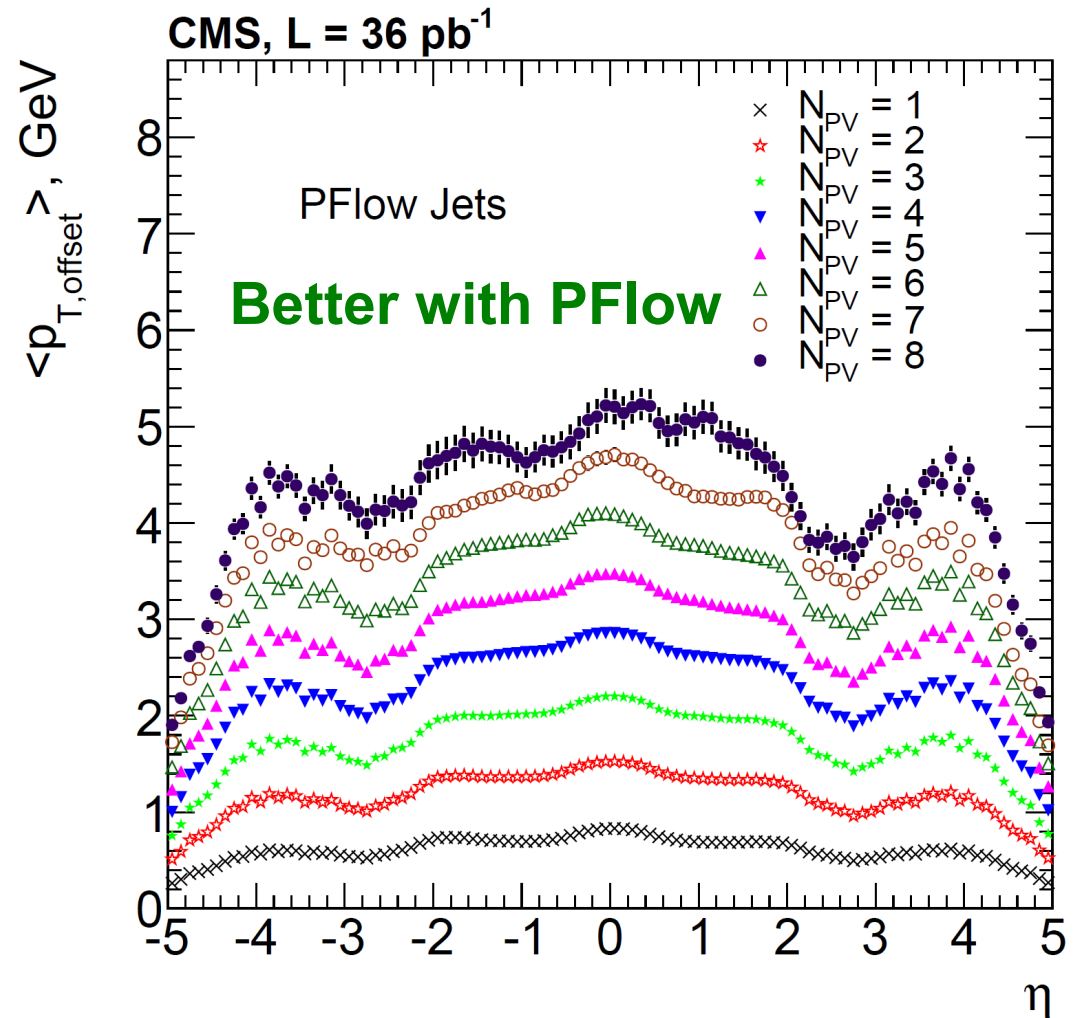
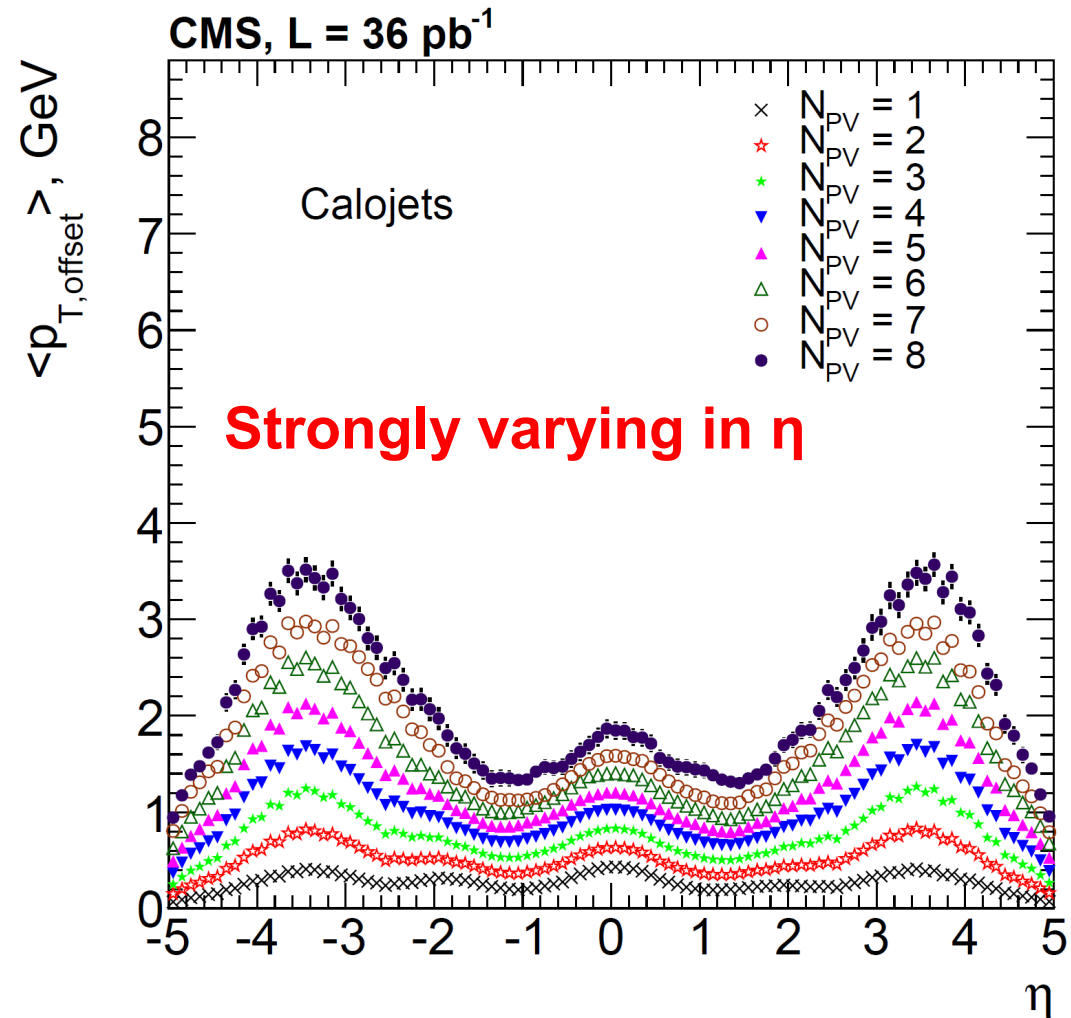



Jet Energy Scale and Pile Up

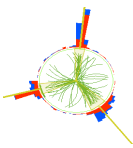

New situation in 2012 at 8 TeV with many pile-up collisions!
And what about "high lumi"
Running at 13 TeV??

ATLAS Z \rightarrow $\mu\mu$ candidate with 25 reconstructed primary vertices:
(Record beyond 70!)

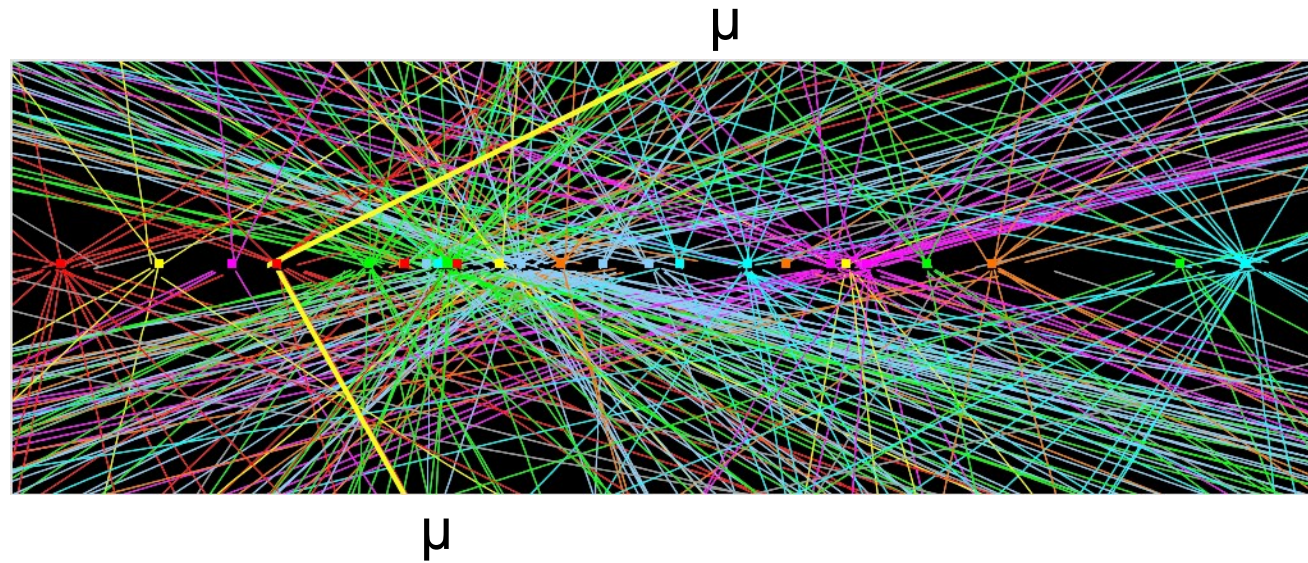

CMS from 5/fb (7 TeV, 2011)

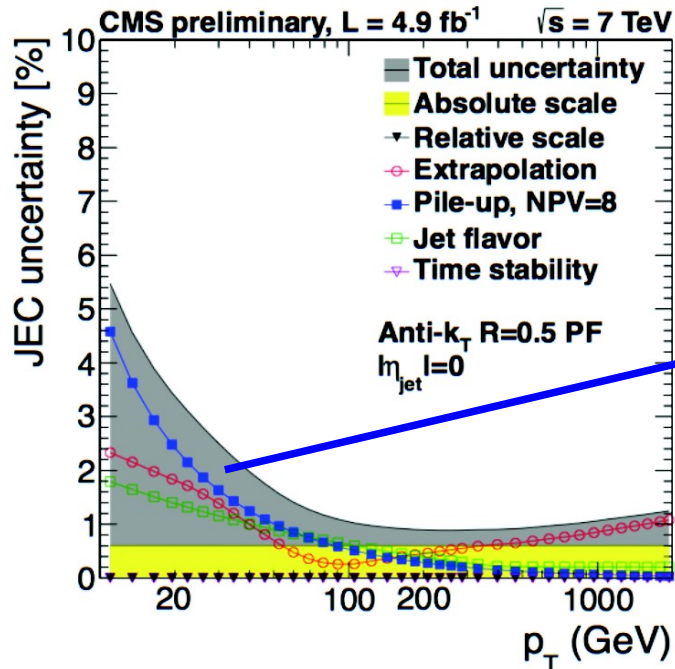

Pile-up effect

CMS from 1.6/fb (8 TeV, 2011)

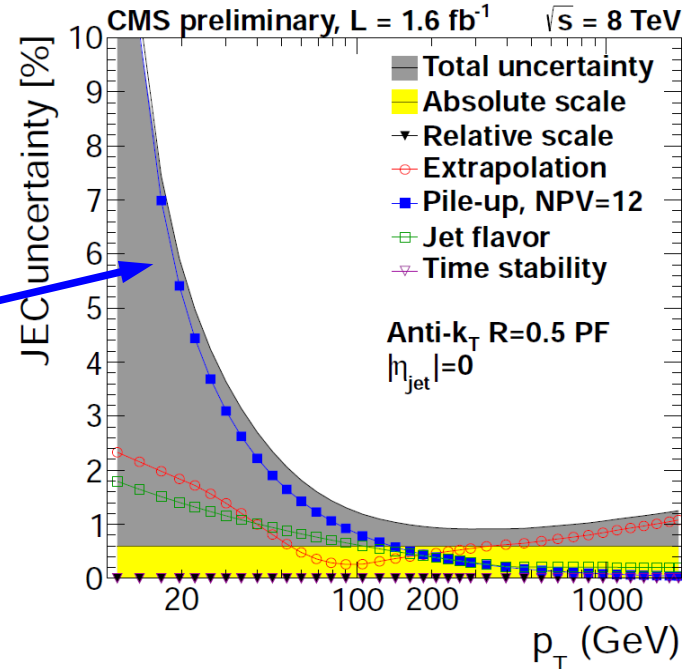

CMS, DP2012-006
CMS, DP2012-012



Relative Correction in η

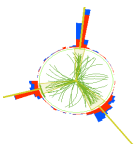

Typical size of correction to equalize detector response versus η
Uses dijet event with one (calibrated) central jet and one forward jet

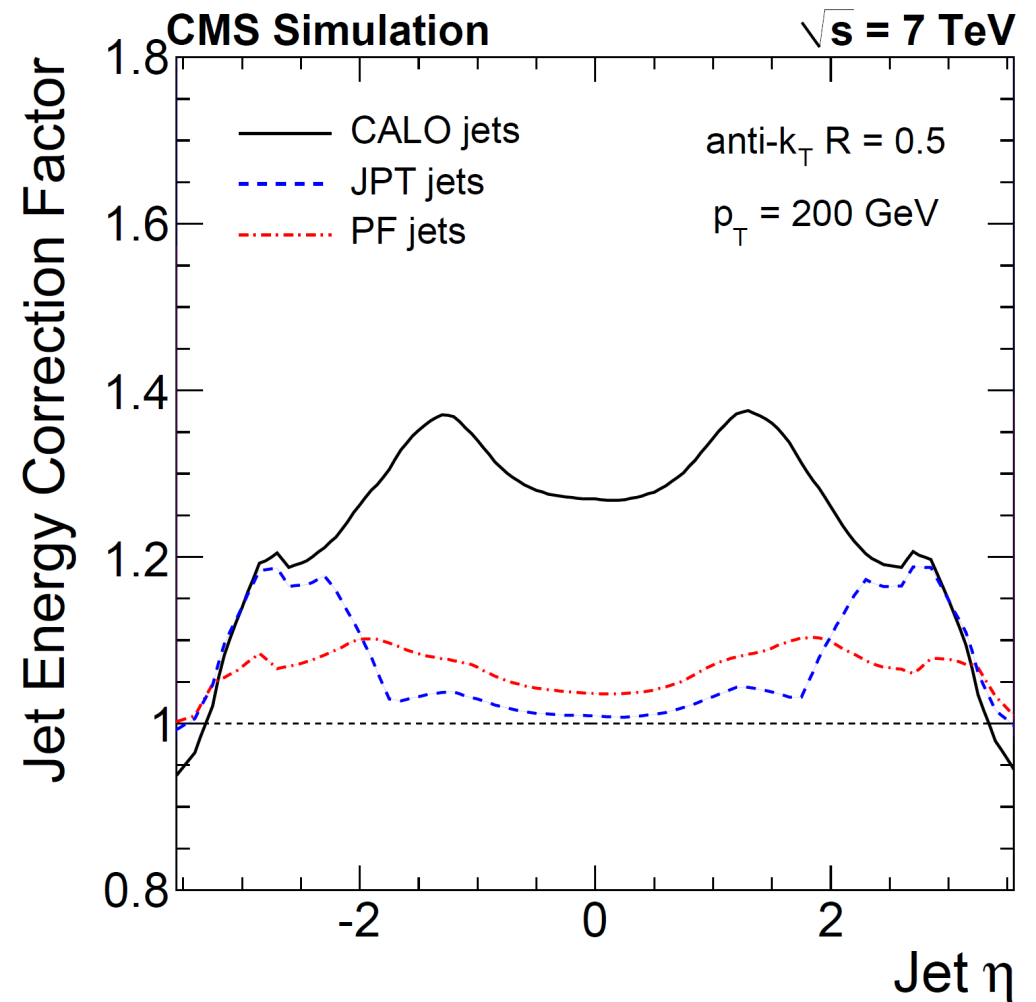
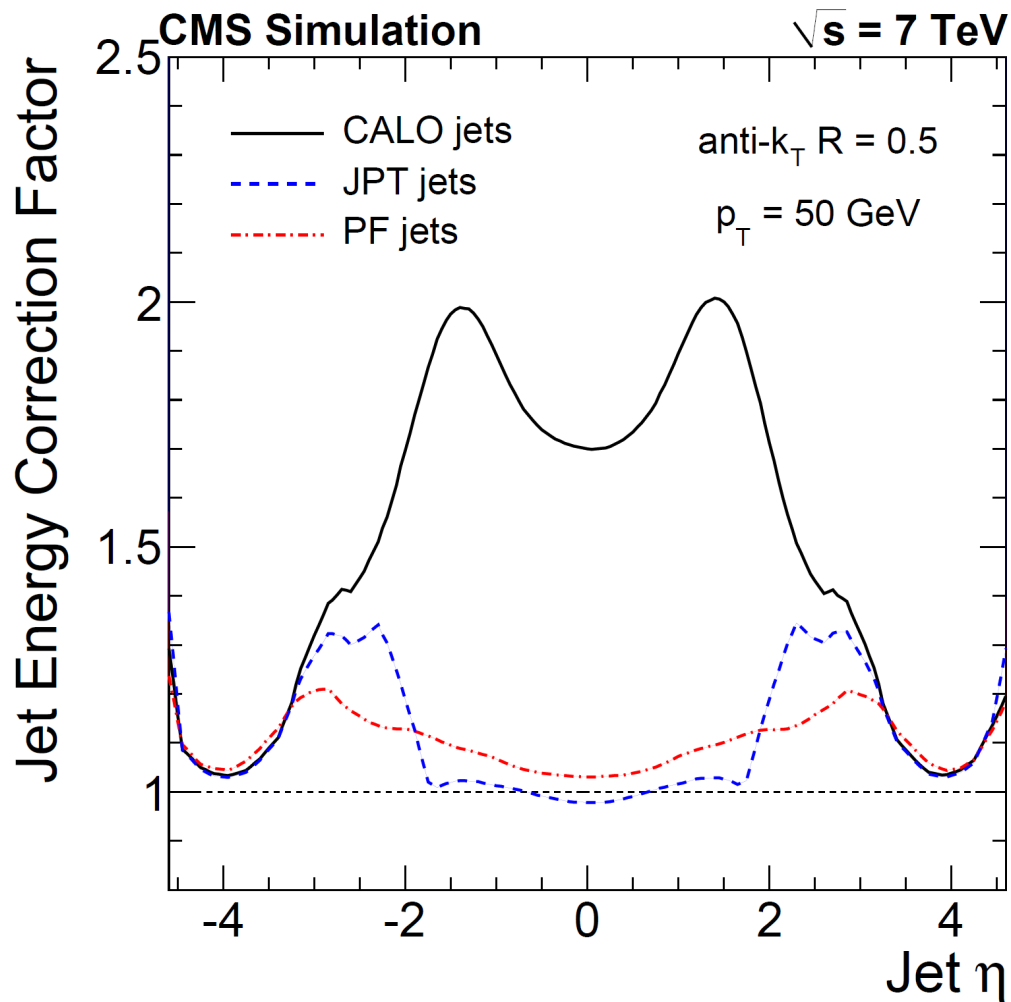

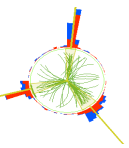

In-situ techniques used to validate JES and its uncertainty

- use well calibrated object(s) as reference for jet p_T
- compare balance of calibrated jets in data and Monte Carlo simulation

Techniques used in ATLAS:

- **Track-jets:** Compare calorimeter jets to track-jets
- **MPF method:** Employ MET projection to check γ and recoil balance
- **Photon-jet balance:** Balance p_T of γ and recoiling jet
- **Z-jet balance (2011):** Balance p_T of $Z \rightarrow ee$ with recoil jet [ATLAS-CONF-2011-159]
- **Multi-jet balance:** Balance high p_T jet with recoil system

Photon-jet balance

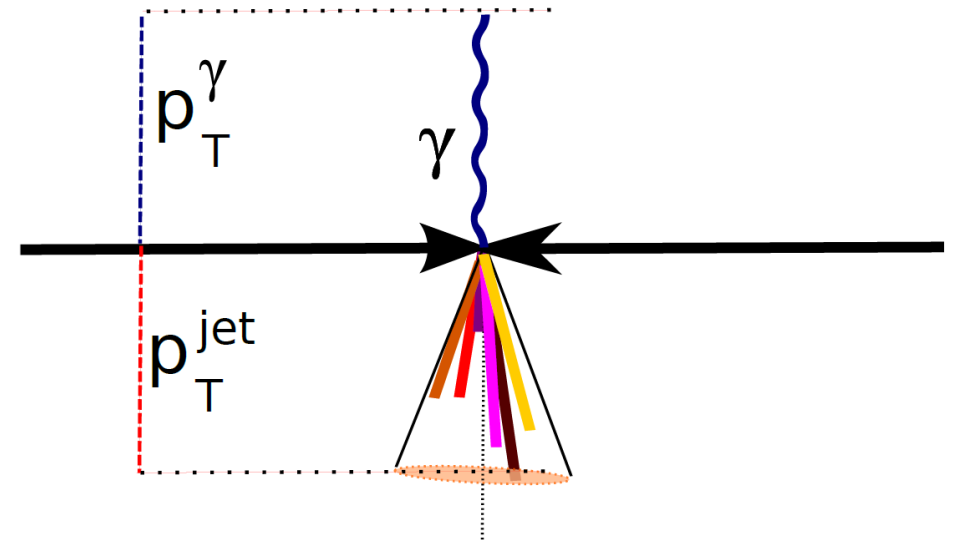

CERN Seminar, ATLAS Vortrag,
C. Doglioni, 28.05.2012

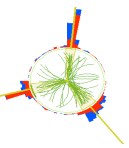

In-situ techniques used to validate JES and its uncertainty

- use well calibrated object(s) as reference for jet p_T
- compare balance of calibrated jets in data and Monte Carlo simulation

CMS uses both: $Z \rightarrow ee$ and $Z \rightarrow \mu\mu$

Techniques used in ATLAS:

- **Track-jets:** Compare calorimeter jets to track-jets
- **MPF method:** Employ MET projection to check γ and recoil balance
- **Photon-jet balance:** Balance p_T of γ and recoiling jet
- **Z-jet balance (2011):** Balance p_T of $Z \rightarrow ee$ with recoil jet [ATLAS-CONF-2011-159]
- **Multi-jet balance:** Balance high p_T jet with recoil system

Z-jet balance

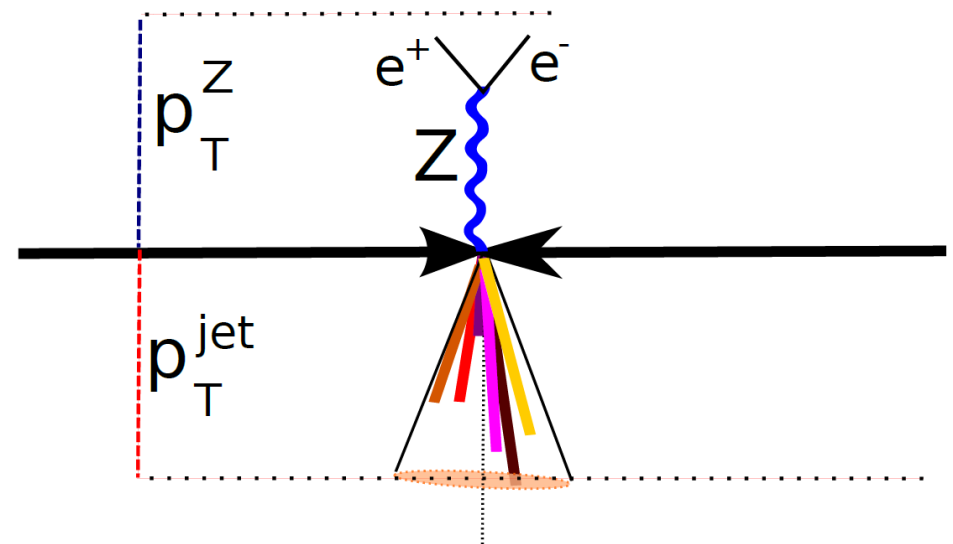

CERN Seminar, ATLAS Vortrag,
C. Doglioni, 28.05.2012

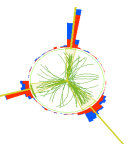

In-situ techniques used to validate JES and its uncertainty

- use well calibrated object(s) as reference for jet p_T
- compare balance of calibrated jets in data and Monte Carlo simulation

Beyond this channel: MC extrapolation

Techniques used in ATLAS:

- **Track-jets:** Compare calorimeter jets to track-jets
- **MPF method:** Employ MET projection to check γ and recoil balance
- **Photon-jet balance:** Balance p_T of γ and recoiling jet
- **Z-jet balance (2011):** Balance p_T of $Z \rightarrow ee$ with recoil jet [ATLAS-CONF-2011-159]
- **Multi-jet balance:** Balance high p_T jet with recoil system

Multi-jet balance

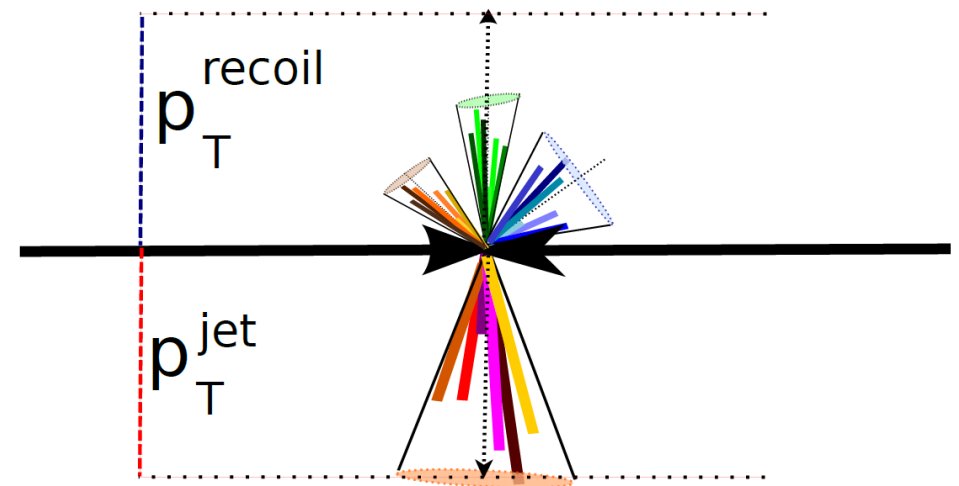

CERN Seminar, ATLAS Vortrag,
C. Doglioni, 28.05.2012



Jet Energy Scale

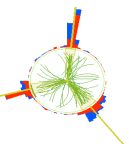

Dominant uncertainty for measurements of jet cross sections ...

Enormous progress ... in two years LHC arrived where it took O(10) years at Tevatron!

QCD at hadron colliders is becoming precision physics.

**ATLAS from 5/fb (2011)
(Z → ee)+jet channel**

**Determine absolute scale
e.g. via jet pT balancing
versus photon γ,
Z(→ μμ), or ...**

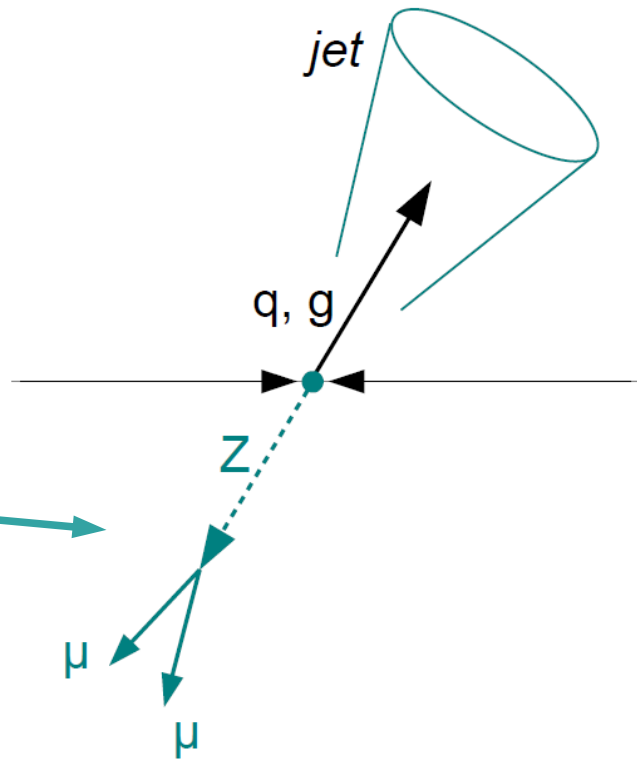

**CMS:
J. Berger &
D. Haitz (KIT)**

**Most precise channel,
Final results not yet public.**

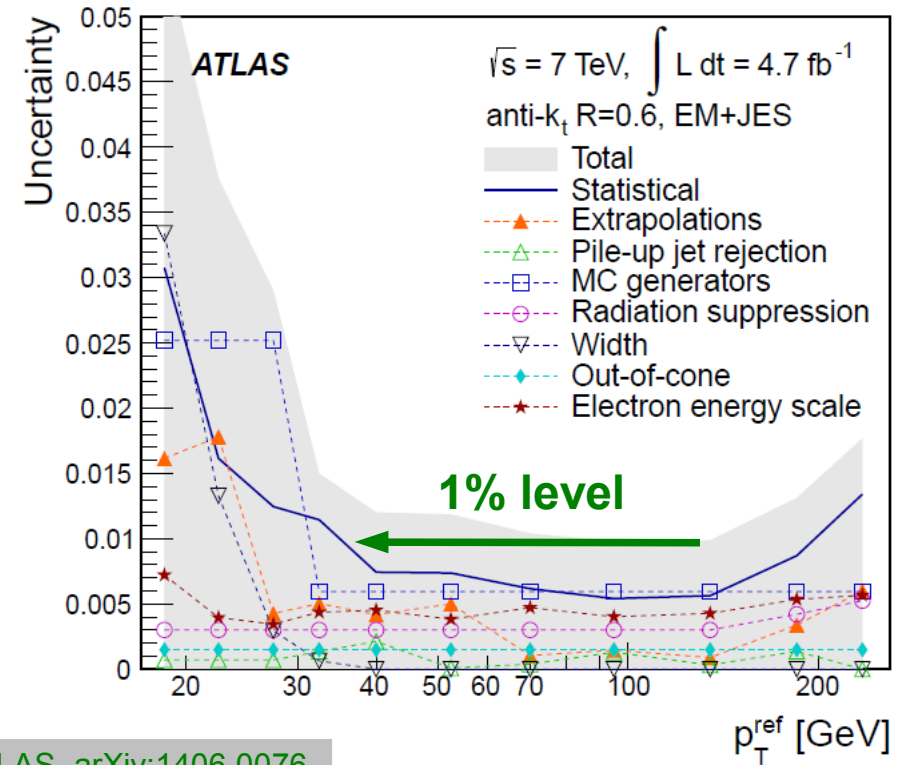

ATLAS, arXiv:1406.0076.

Why is the JES so important?

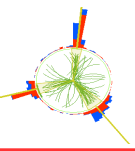

Steeply falling spectra

$$\frac{d^2\sigma}{dp_T dy} \propto \frac{1}{p_T^{5-6}}$$

Factor 5 – 6 on uncertainty from JES:
5% → 30%, 2% → 12%

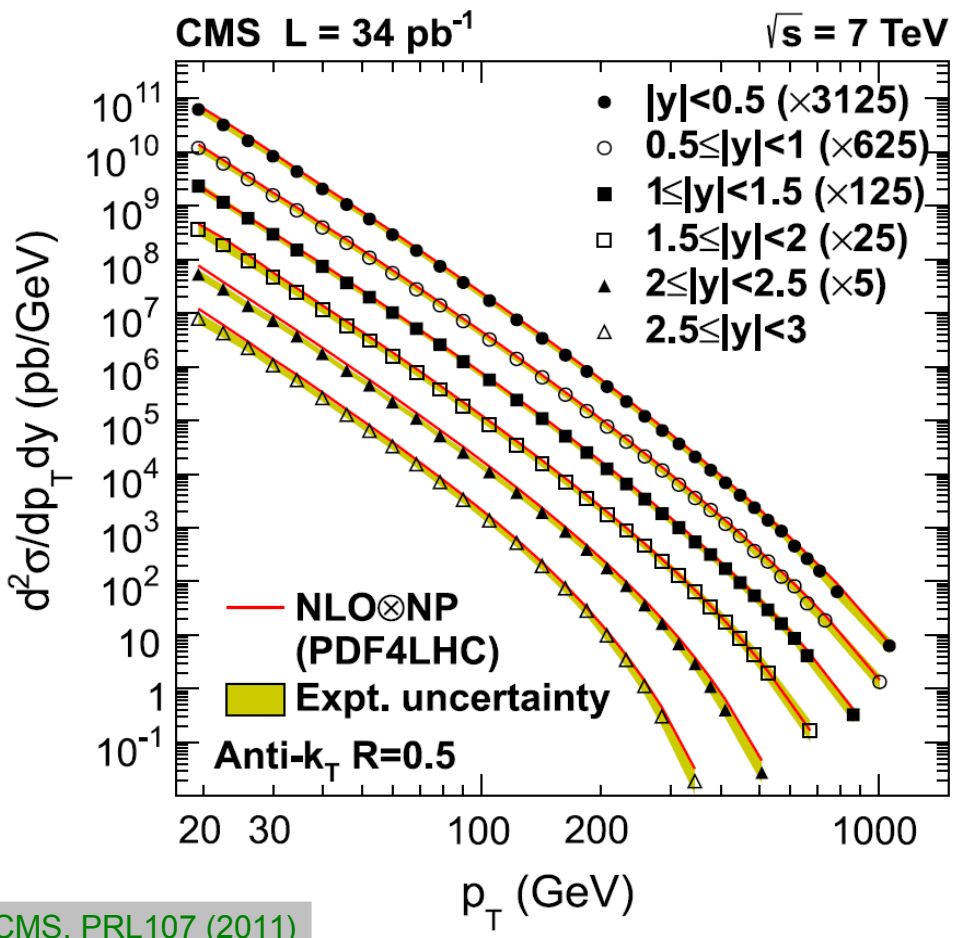

CMS, PRL107 (2011)

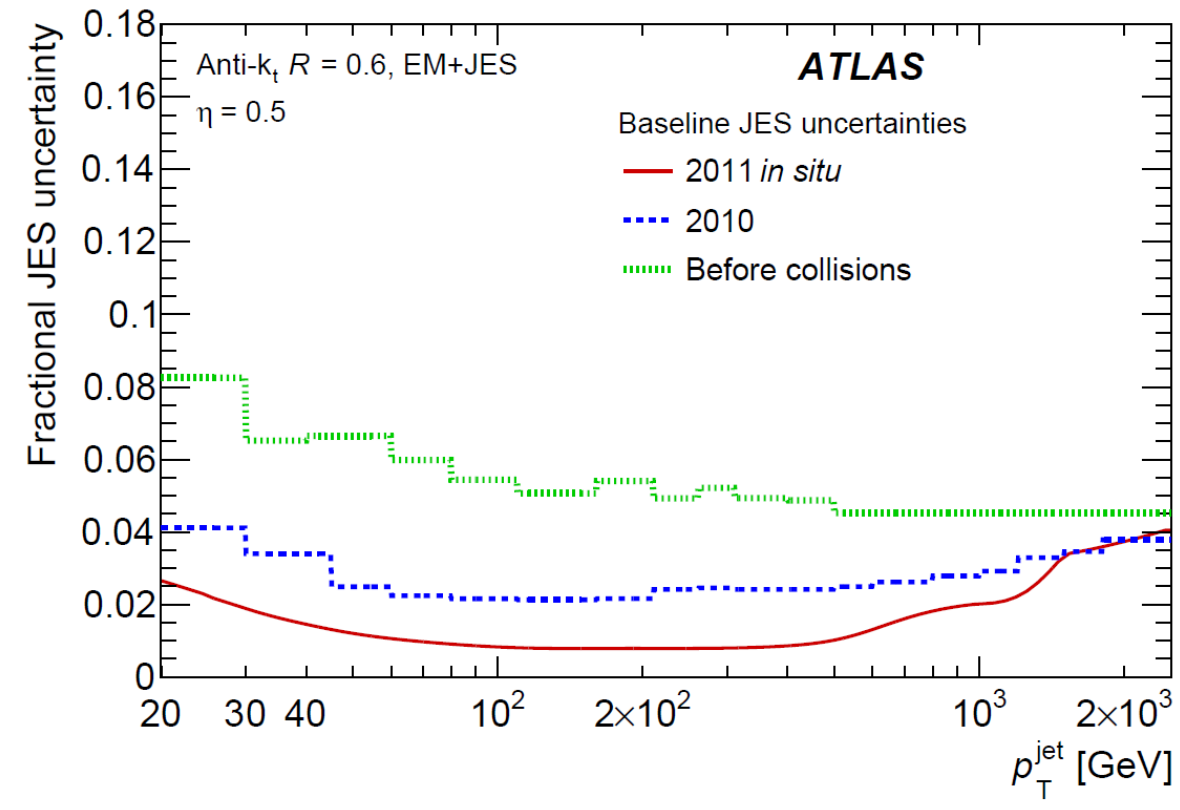

ATLAS, arXiv:1406.0076.



All Inclusive

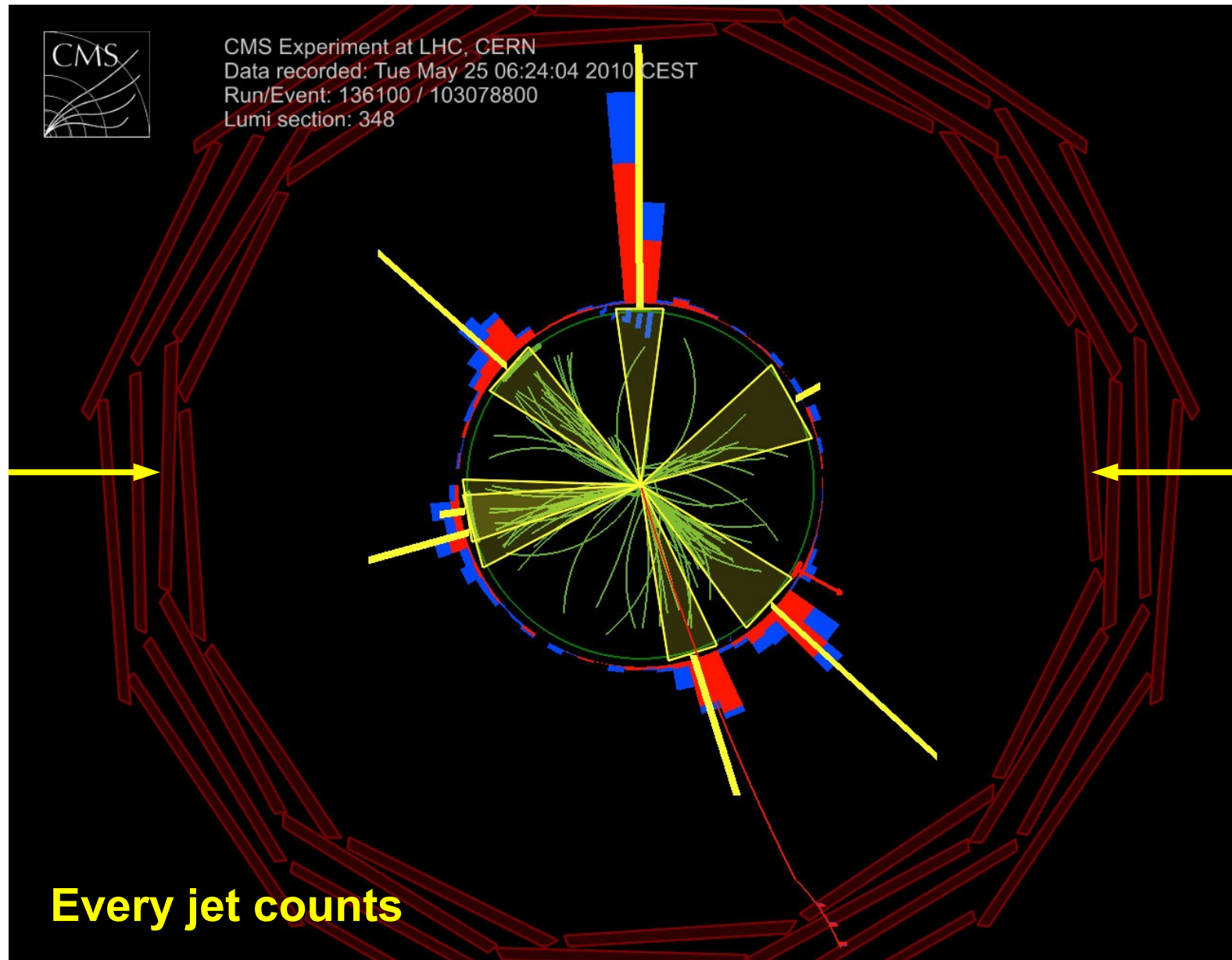
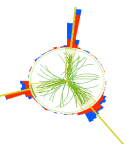



Inclusive Jets

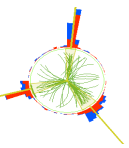

Agreement with predictions of QCD at NLO over many orders of magnitude in cross section and even beyond 2 TeV in jet p_T and for rapidities $|y|$ up to ~ 5
 Similar picture at 7 TeV, 8 TeV (CMS left) or 2.76 TeV (ATLAS right)

$$\frac{d^2\sigma}{dp_T dy} \propto \alpha_s^2$$

anti-kT, R=0.7, 8 TeV, 2012

Data vs. NLO pQCD
 ⊗ non-perturbative corrections

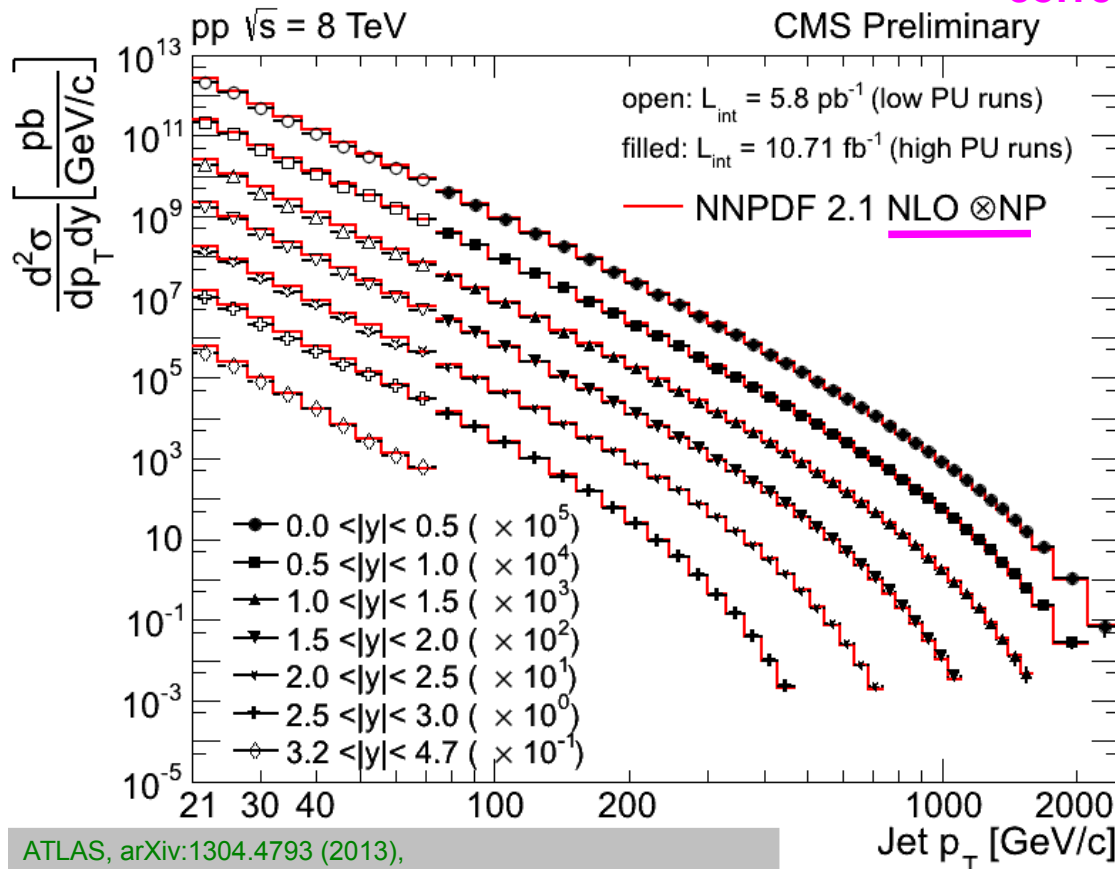

anti-kT, R=0.6, 2.76 TeV, 2012

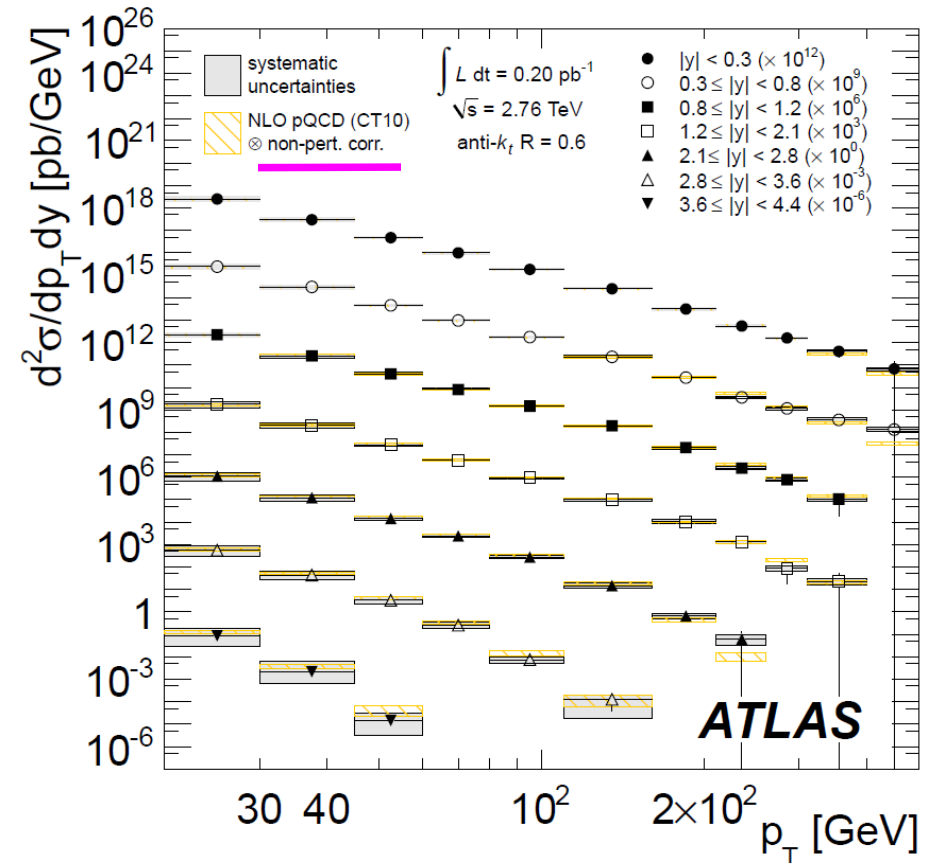

ATLAS, arXiv:1304.4793 (2013),
 CMS-PAS-SMP-12-012 (2013), CMS-PAS-FSQ-12-031 (2013).



Background ?

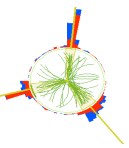

Safety selection
to avoid detector
issues and Z,W+jets

top background ?
LO production of
t**tb**ar → (4+) jets!
For 7, 8 TeV orders
of magnitude smaller

Interesting part

Section for searches

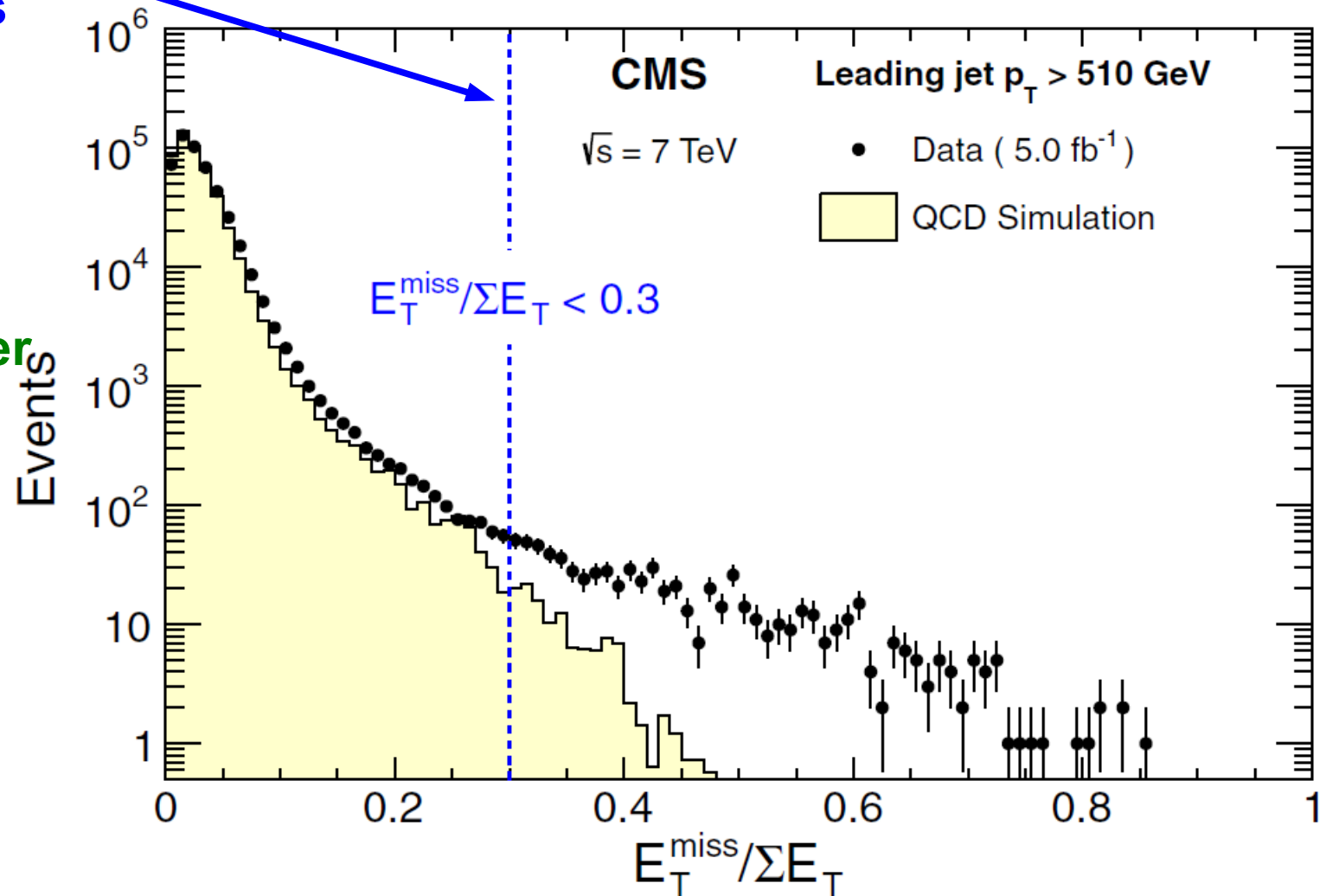



Uncertainties

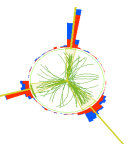

Experimental Uncertainties

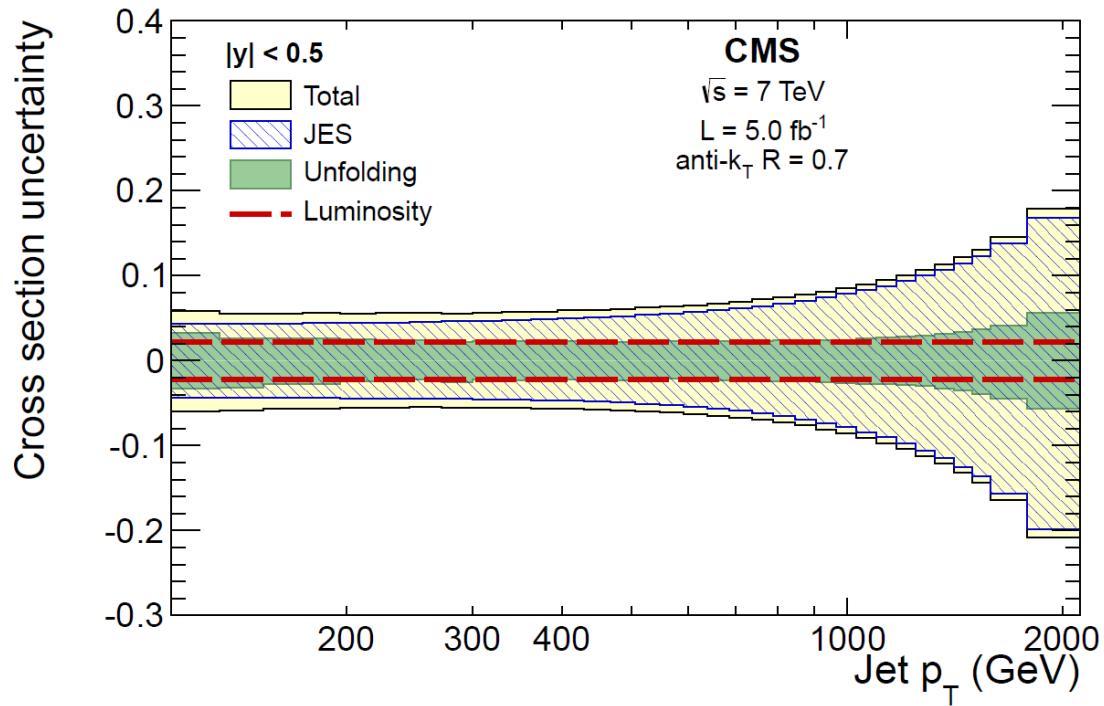

Theoretical Uncertainties

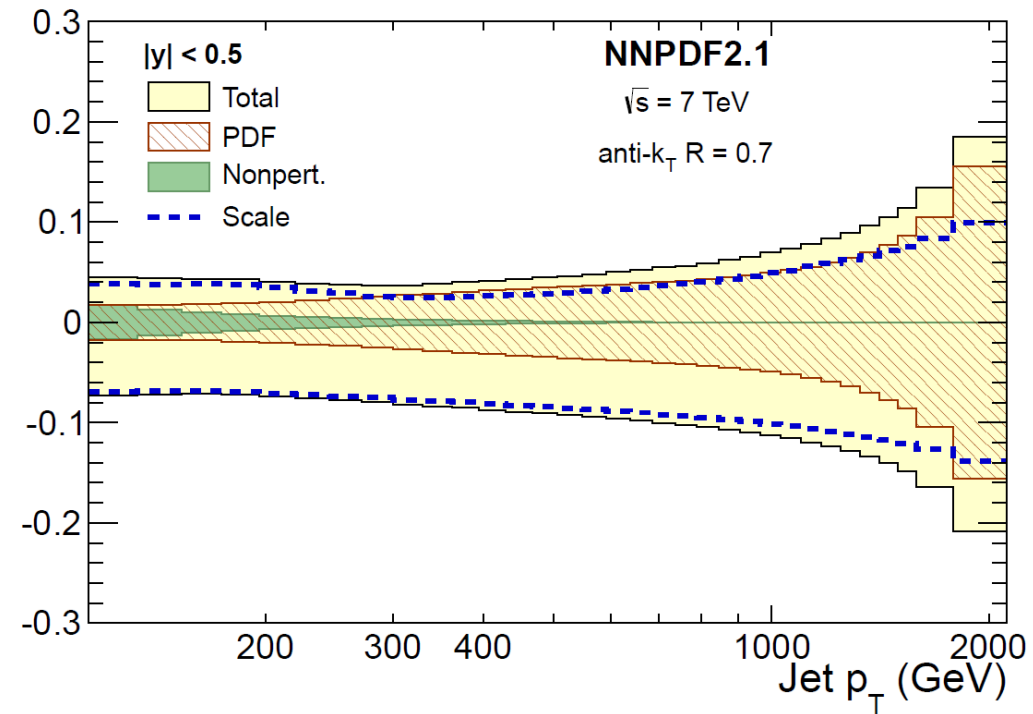

Desperately seeking NNLO!



Progress in Theory

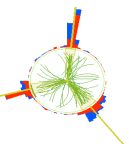

Jet p_T at NNLO (gluon-gluon only)

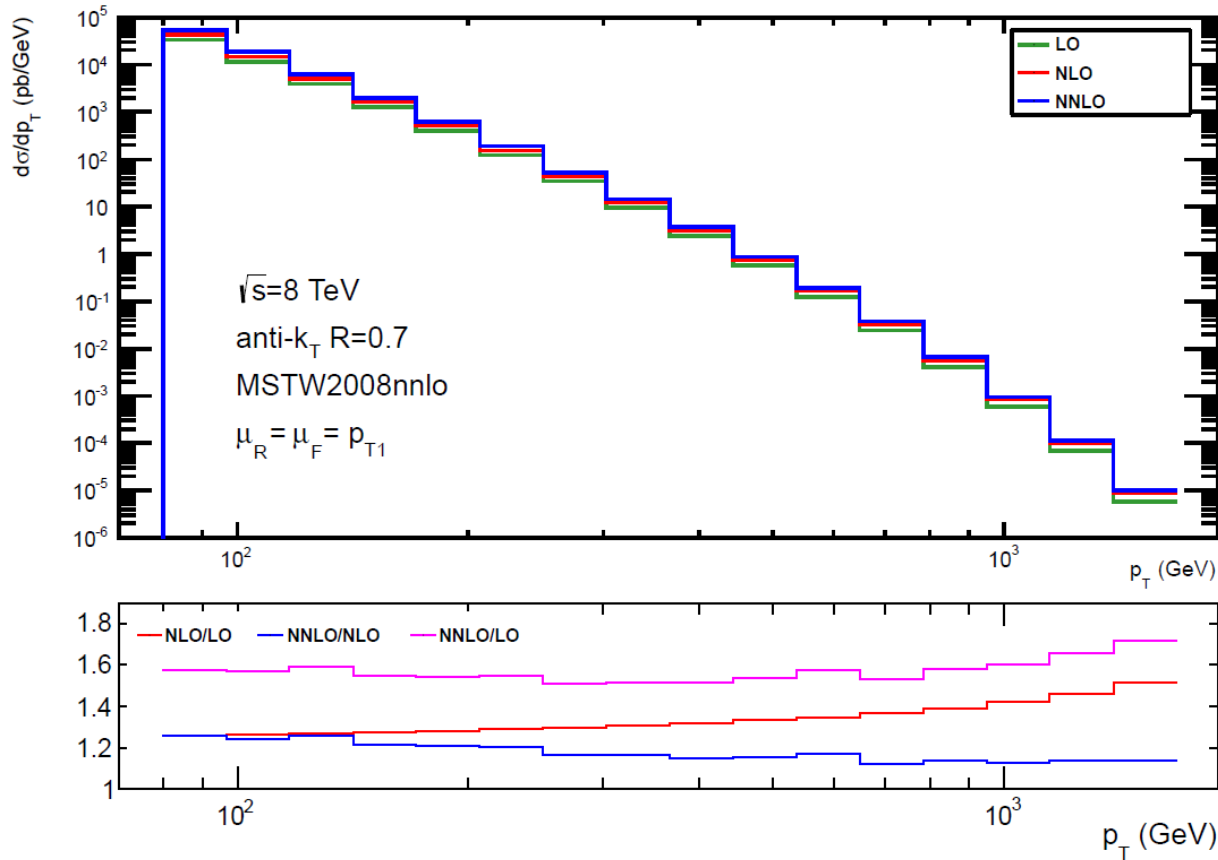

K factors

From talk by N. Glover:
 Gehrmann- de Ridder, Gehrmann, Glover, Pires

Electroweak corrections $\propto \alpha\alpha_s^2$

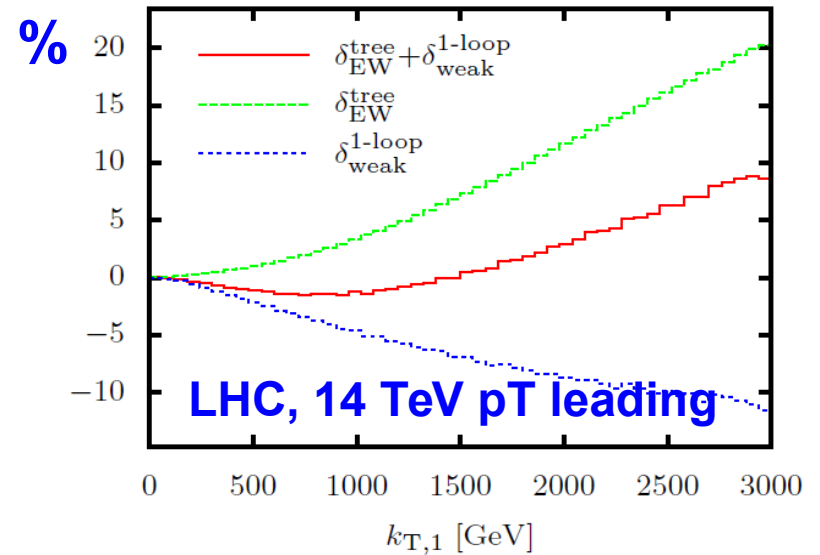
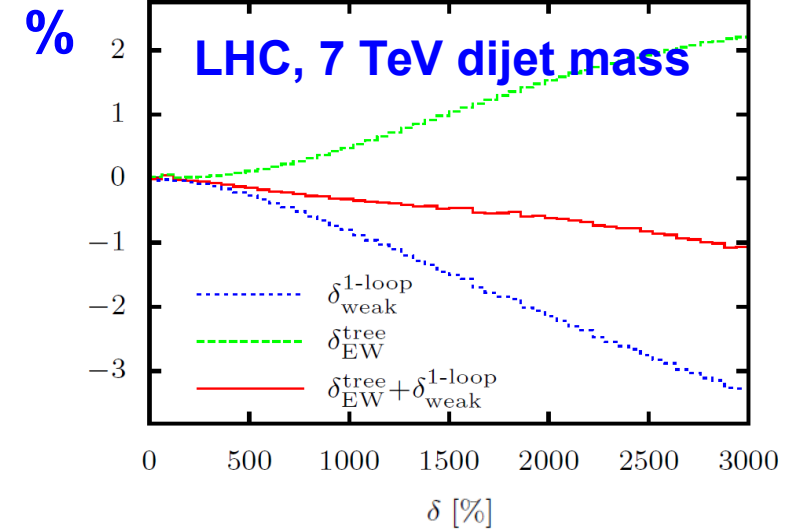

S. Dittmaier, A. Huss, C. Speckner, JHEP11 (2012).



Correlation to PDFs

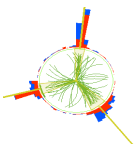

Correlation to quark PDFs and in particular to gluon PDF!

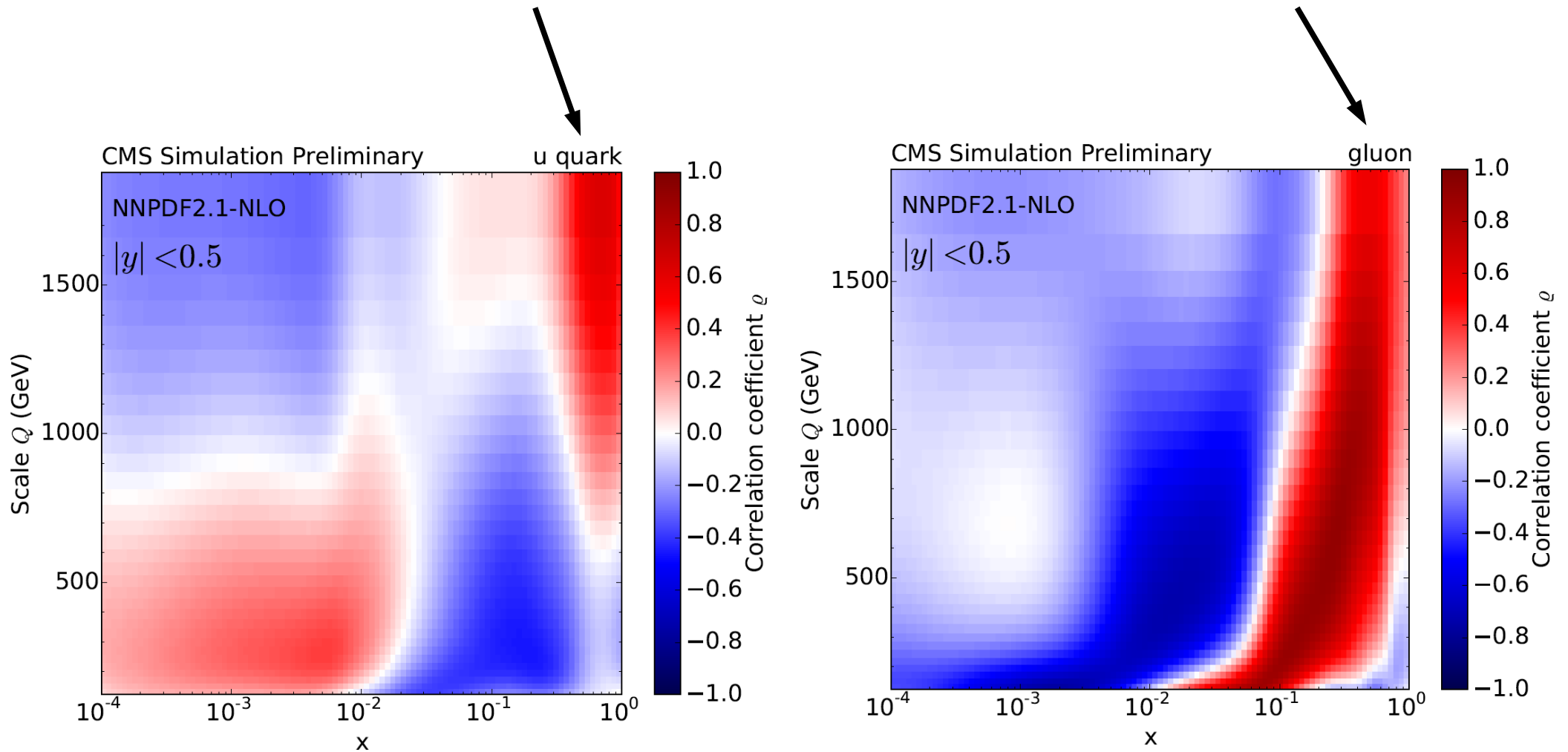

CMS-PAS-SMP-12-028: G. Sieber (KIT)

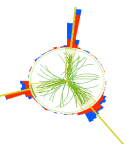

PDF Parameterization

$$xg(x) = A_g x^{B_g} (1-x)^{C_g} - A'_g x^{B'_g} (1-x)^{C'_g}$$

$$xu_v(x) = A_{u_v} x^{B_{u_v}} (1-x)^{C_{u_v}} (1 + E_{u_v} x^2)$$

$$xd_v(x) = A_{d_v} x^{B_{d_v}} (1-x)^{C_{d_v}}$$

$$x\bar{U}(x) = A_{\bar{U}} x^{B_{\bar{U}}} (1-x)^{C_{\bar{U}}}$$

$$x\bar{D}(x) = A_{\bar{D}} x^{B_{\bar{D}}} (1-x)^{C_{\bar{D}}}$$

Employed theory here is:

NLO QCD

(NLOJet++, Z Nagy)

NP Correction

(Pythia, Herwig++, POWHEG+Pythia)

Electroweak Correction

(Dittmaier, Huss, Speckner)

CMS-PAS-SMP-12-028: G. Sieber (KIT)

PDF fitting with HERAFitter as in HERAPDF1.0 using DIS data and then add CMS jets data

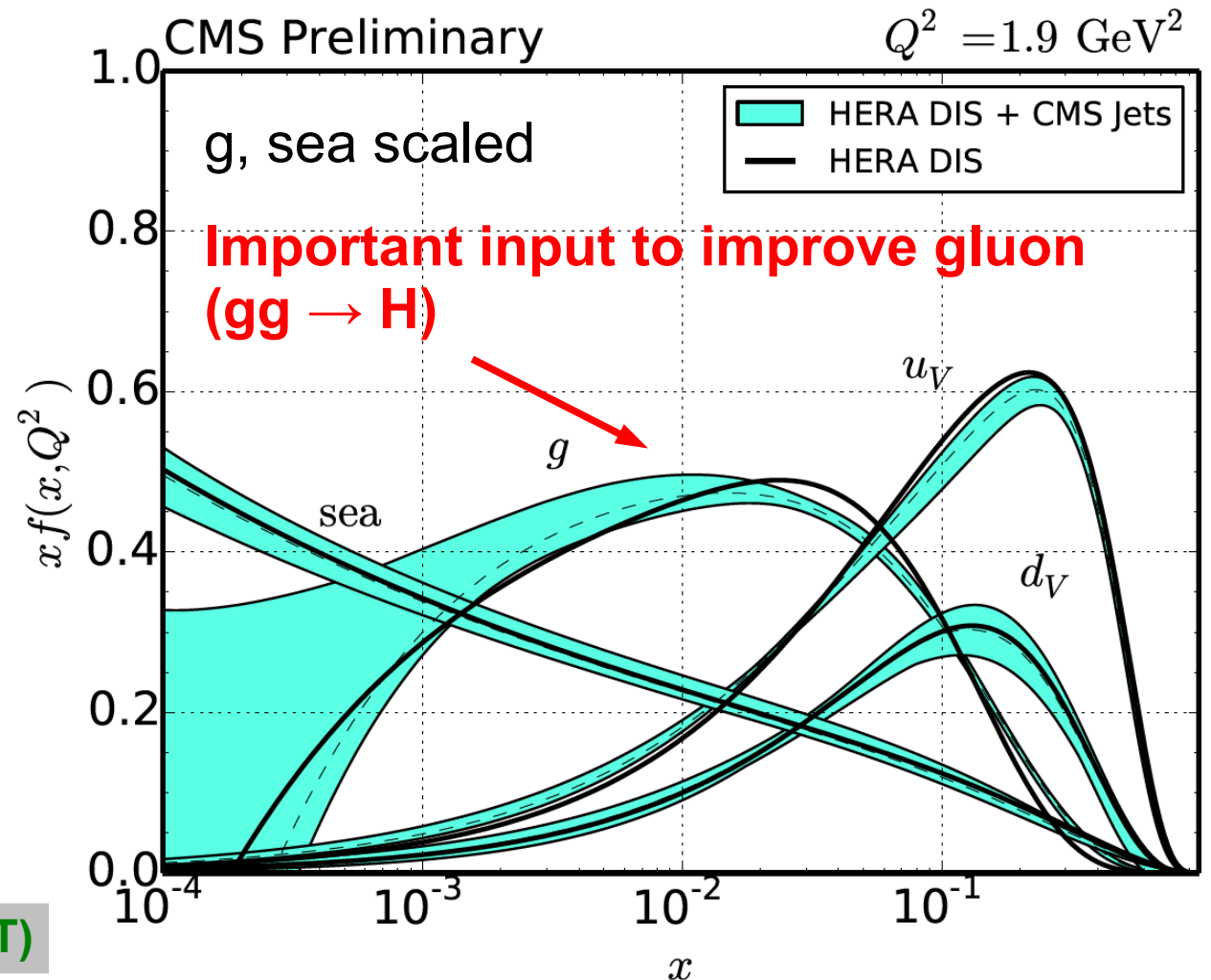



Thanks for your Attention

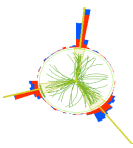

Appetizer for tomorrow

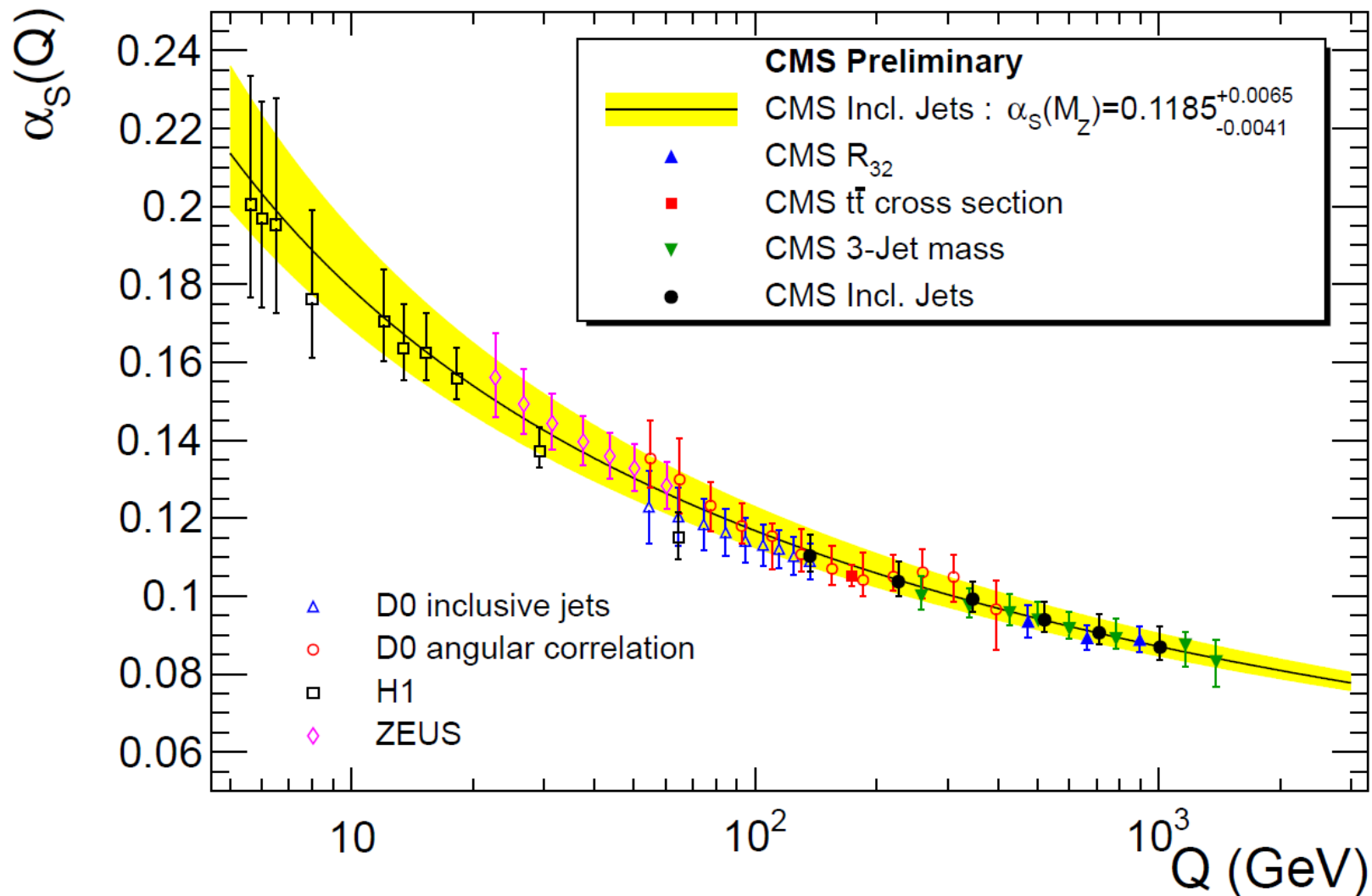



Backup slides

